

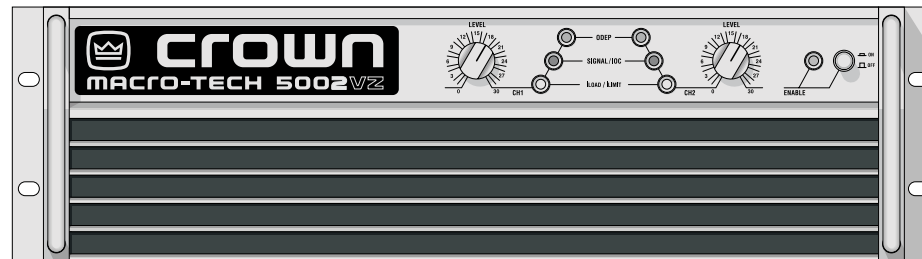

Macro-Tech Series

Operation Manual



MA-5002VZ

Obtaining Other Language Versions: To obtain information in another language about the use of this product, please contact your local Crown Distributor. If you need assistance locating your local distributor, please contact Crown at 574-294-8000.

This manual does not include all of the details of design, production, or variations of the equipment. Nor does it cover every possible situation which may arise during installation, operation or maintenance.

Note: The information provided in this manual was deemed accurate as of the publication date. However, updates to this information may have occurred. To obtain the latest version of this manual, please visit the Crown website at www.crownaudio.com.

Trademark Notice: Grounded Bridge, PIP and PIP2 are trademarks, and Amcron, Crown, Crown Audio, IOC, VZ, and ODEP are registered trademarks, and IQwic is a trademark of Crown International. Other trademarks are the property of their respective owners.

Some models may be exported under the name Amcron.®

Important Safety Instructions

Importantes Instruccions de Sécurité

- 1) Read these instructions.
- 2) Keep these instructions.
- 3) Heed all warnings.
- 4) Follow all instructions.
- 5) Do not use this apparatus near water.
- 6) Clean only with a dry cloth.
- 7) Do not defeat the safety purpose of the polarized or grounding-type plug. A polarized plug has two blades with one wider than the other. A grounding-type plug has two blades and a third grounding prong. The wide blade or the third prong is provided for your safety. If the provided plug does not fit into your outlet, consult an electrician for replacement of the obsolete outlet.
- 8) Do not install near any heat sources such as radiators, heat registers, stoves, or other apparatus (including amplifiers) that produce heat.
- 9) Do not defeat the safety purpose of the polarized or grounding-type plug. A polarized plug has two blades with one wider than the other. A grounding-type plug has two blades and a third grounding prong. The wide blade or the third prong is provided for your safety. If the provided plug does not fit into your outlet, consult an electrician for replacement of the obsolete outlet.
- 10) Protect the power cord from being walked on or pinched, particularly at plugs, convenience receptacles, and the point where they exit from the apparatus.
- 11) Only use attachments/accessories specified by the manufacturer.
- 12) Use only with a cart, stand, tripod, bracket, or table specified by the manufacturer, or sold with the apparatus. When a cart is used, use caution when moving the cart/apparatus combination to avoid injury from tip-over.
- 13) Unplug this apparatus during lightning storms or when unused for long periods of time.
- 14) Refer all servicing to qualified service personnel. Servicing is required when the apparatus has been damaged in any way, such as power-supply cord or plug is damaged, liquid has been spilled or objects have fallen into the apparatus, the apparatus has been exposed to rain or moisture, does not operate normally, or has been dropped.
- 15) **WARNING: TO REDUCE THE RISK OF FIRE OR ELECTRIC SHOCK, DO NOT EXPOSE THIS APPARATUS TO RAIN OR MOISTURE.**
- 16) **DO NOT EXPOSE TO DRIPPING OR SPLASHING. DO NOT PLACE OBJECTS FILLED WITH LIQUID, SUCH AS VASES, ON THIS APPARATUS.**



Wichtige Sicherheitsinstruktionen

Instrucciones de Seguridad Importantes

TO PREVENT ELECTRIC SHOCK DO NOT REMOVE TOP OR BOTTOM COVERS. NO USER SERVICEABLE PARTS INSIDE. REFER SERVICING TO QUALIFIED SERVICE PERSONNEL.

À PRÉVENIR LE CHOC ÉLECTRIQUE N'ENLEVEZ PAS LES COUVERCLES. IL N'Y A PAS DES PARTIES SERVICEABLE À L'INTÉRIEUR. TOUS REPARATIONS DOIT ÊTRE FAIRE PAR PERSONNEL QUALIFIÉ SEULMENT.

PARA PREVENIR UN CHOQUE ELÉCTRICO, NO RETIRE LAS CUBIERTAS SUPERIOR O INFERIOR. NO EXISTEN PARTES QUE PUEDAN SER REPARADAS POR EL USUARIO AL INTERIOR. REMITA EL SERVICIO AL PERSONAL TÉCNICAL CALIFICADO.

TO COMPLETELY DISCONNECT THIS EQUIPMENT FROM THE AC MAINS, DISCONNECT THE POWER SUPPLY CORD PLUG FROM THE AC RECEPTACLE. THE MAINS PLUG OF THE POWER SUPPLY CORD SHALL REMAIN READILY OPERABLE.

POUR DÉMONTÉ COMPLÈTEMENT L'ÉQUIPEMENT DE L'ALIMENTATION GÉNÉRALE, DÉMONTÉ LE CÂBLE D'ALIMENTATION DE SON RÉCEPTACLE. LA PRISE D'ALIMENTATION RESTERA AISÉMENT FONCTIONNELLE.

PARA DESCONECTAR COMPLETAMENTE EL EQUIPO DEL SUMINISTRO ELECTRICO, DESCONECTE EL CABLE DE ALIMENTACION DE LA TOMA DE CA. LAS PATAS DEL CONECTOR DEL CABLE DE ALIMENTACION DEBERAN MANTENERSE EN BUEN ESTADO.

WATCH FOR THESE SYMBOLS:

The lightning bolt triangle is used to alert the user to the risk of electric shock.

The exclamation point triangle is used to alert the user to important operating or maintenance instructions.

REGARDEZ CES SYMBOLES

La triangle avec le sigle "foudre" est employée pour alerter l'utilisateur au risque de décharge électrique. Le triangle avec un point d'exclamation est employée pour alerter l'utilisateur d'instruction importantes pour lors opérations de maintenance.

ATENCION CON ESTOS SÍMBOLOS

El triángulo con el símbolo de rayo eléctrico es usado para alertar al usuario de el riesgo de un choque eléctrico.

El triángulo con el signo de admiración es usado para alertar al usuario de instrucciones importantes de operación o mantenimiento.



CAUTION
RISK OF ELECTRIC SHOCK
DO NOT OPEN

AVIS
RISQUE DE CHOC ÉLECTRIQUE
N'OUVREZ PAS



IMPORTANT

MA Series amplifiers require Class 2 output wiring. Les amplificateurs de série de MA exigent des câbles de sortie de classe 2. MA-Reihe-Verstärker verlangen Klasse die 2 Produktionsverdrahtung. Los amplificadores de la Serie MA requieren de un cableado de salida Clase 2.

MAGNETIC FIELD

CAUTION! Do not locate sensitive high-gain equipment such as preamplifiers or tape decks directly above or below the unit. Because this amplifier has a high power density, it has a strong magnetic field which can induce hum into unshielded devices that are located nearby. The field is strongest just above and below the unit.

If an equipment rack is used, we recommend locating the amplifier(s) in the bottom of the rack and the preamplifier or other sensitive equipment at the top.

FCC COMPLIANCE NOTICE

This device complies with part 15 of the FCC rules. Operation is subject to the following two conditions: (1) This device may not cause harmful interference, and (2) this device must accept any interference received, including interference that may cause undesired operation.

CAUTION: Changes or modifications not expressly approved by the party responsible for compliance could void the user's authority to operate the equipment.

NOTE: This equipment has been tested and found to comply with the limits for a Class B digital device, pursuant to part 15 of the FCC Rules. These limits are designed to provide reasonable protection against harmful interference in a residential installation. This equipment generates, uses, and can radiate radio frequency energy and, if not installed and used in accordance with the instruction manual, may cause harmful interference to radio communications. However, there is no guarantee that interference will not occur in a particular installation. If this equipment does cause harmful interference to radio or television reception, which can be determined by turning the equipment off and on, the user is encouraged to try to correct the interference by one or more of the following measures:

- Reorient or relocate the receiving antenna.
- Increase the separation between the equipment and receiver.
- Connect the equipment into an outlet on a circuit different from that to which the receiver is connected.
- Consult the dealer or an experienced radio/TV technician for help.

Crown International, Inc.

DECLARATION of CONFORMITY

TCF Technical Certificate No: C1017CRI.ABS

Technical Construction File Route

Issued By: Crown International, Inc.
1718 W. Mishawaka Road
Elkhart, Indiana 46517 U.S.A.

FOR COMPLIANCE QUESTIONS ONLY: Sue Whitfield
574-294-8289
swhitfield@crowintl.com

Competent Body's Name and Address:

Technology International (Europe) Limited
41-42 Shrivenham Hundred Business Park,
Shrivenham, Swindon, Wilts, SN6 8TZ

European Representative's Name and Address:

Nick Owen
35, Bassets Field
Thornhill
Cardiff, South Glamorgan
CF14 9UG United Kingdom

Equipment Type: Commercial Audio Power Amplifiers

Family Name: MACRO-TECH 5002VZ

Model Names: MA5002VZE10CE MA5002VZE17CE MA5002VZE14CE

EMC Standards:

EN 55103-1:1995 Electromagnetic Compatibility - Product Family Standard for Audio, Video, Audio-Visual and Entertainment Lighting Control Apparatus for Professional Use, Part 1: Emissions

EN 55103-1:1995 Magnetic Field Emissions-Annex A @ 10 cm and 1 M

EN 61000-3-2:1995+A14:2000 Limits for Harmonic Current Emissions (equipment input current ≤16A per phase)

EN 61000-3-3:1995 Limitation of Voltage Fluctuations and Flicker in Low-Voltage Supply Systems Rated Current ≤16A

EN 55022:1992 + A1: 1995 & A2:1997 Limits and Methods of Measurement of Radio Disturbance Characteristics of ITE: Radiated, Class B Limits; Conducted, Class B

EN 55103-2:1996 Electromagnetic Compatibility - Product Family Standard for Audio, Video, Audio-Visual and Entertainment Lighting Control Apparatus for Professional Use, Part 2: Immunity

EN 61000-4-2:1995 Electrostatic Discharge Immunity (Environment E2-Criteria B, 4k V Contact, 8k V Air Discharge)

EN 61000-4-3:1996 Radiated, Radio-Frequency, Electromagnetic Immunity (Environment E2, criteria A)

EN 61000-4-4:1995 Electrical Fast Transient/Burst Immunity (Criteria B)

EN 61000-4-5:1995 Surge Immunity (Criteria B)

EN 61000-4-6:1996 Immunity to Conducted Disturbances Induced by Radio-Frequency Fields (Criteria A)

EN 61000-4-11:1994 Voltage Dips, Short Interruptions and Voltage Variation

Safety Standard:

EN 60065: 1998 Safety Requirements - Audio Video and Similar Electronic Apparatus

I certify that the product identified above conforms to the requirements of the EMC Council Directive 89/336/EEC as amended by 92/31/EEC, and the Low Voltage Directive 73/23/EES as amended by 93/68/EEC.

Signed

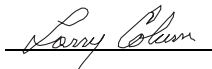

Larry Coburn

Title: Senior Vice President of Manufacturing

Date of Issue: March 28, 2000

Table of Contents

Important Safety Instructions	2	5 Advanced Features and Options	15
Declaration of Conformity.....	3	5.1 Protection Systems	15
1 Welcome	5	5.1.2 Output Device Emulation Protection (ODEP)	15
1.1 Features.....	5	5.1.3 IOC (Input Output Comparator).....	15
2 How to Use This Manual	5	5.2 Circuit Designs	15
3 Setup	6	5.2.1 Grounded Bridge	15
3.1 Unpack Your Amplifier.....	6	5.2.2 Variable Impedance (VZ)	15
3.2 Install Your Amplifier	6	5.2.3 ILoad/ILimit	16
3.3 Ensure Proper Cooling	6	5.2.4 Loudspeaker Offset Integration	16
3.4 Choose Input Wire and Connectors	7	5.3 Options	16
3.5 Choose Output Wire and Connectors	8	5.3.1 PIP Modules	16
3.6 Wire Your System	9	6 Troubleshooting	17
3.6.1 Stereo Mode	9	7 Specifications.....	18
3.6.2 Bridge-Mono Mode	9	8 Service.....	22
3.6.3 Parallel-Mono Mode	10	8.1 International and Canada Service	22
3.7 Connect to AC Mains	11	8.2 US Service	22
3.8 Startup Procedure	11	8.2.1 Service at a US Service Center	22
4 Operation	11	8.2.2 Factory Service	22
4.1 Precautions	11	8.2.3 Factory Service Shipping Instructions.....	22
4.2 Front Panel Controls and Indicators	12	8.2.4 Packing Instructions	22
4.3 Back Panel Controls and Connectors	13	8.2.5 Estimate Approval	22
		8.2.6 Payment of Non-Warranty Repairs	22
		9 Warranty	23
		Product Registration	25
		Factory Service Information Form	27

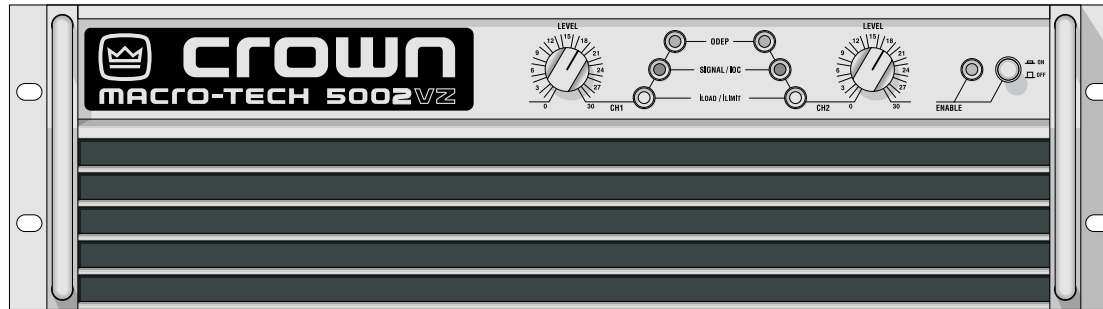

MA-5002VZ	*1 kHz Power	**20 Hz–20 kHz Power
2 ohm Dual (per ch.)	2,500W	2,155W
4 ohm Dual (per ch.)	2,000W	1,775W
8 ohm Dual (per ch.)	1,300W	1,090W
4 ohm Bridge-Mono	5,000W	
8 ohm Bridge-Mono	4,000W	3,670W

*1 kHz Power: refers to maximum average power in watts at 1 kHz with 0.1% THD.
 **20 Hz–20 kHz Power: refers to maximum average power in watts from 20 Hz to 20 kHz with 0.1% THD.

1 Welcome

The Crown® *Macro-Tech*® 5002VZ is the most advanced amplifier to offer Crown's patented Variable Impedance (VZ®) power supply technology. New semiconductor technology is combined with superior VZ power supplies to enable the Macro-Tech 5002VZ to pack unprecedented power levels into 5¼ inches (13.3 cm) of vertical rack space. The Macro-Tech 5002VZ also features enhanced PIP2™ compatibility for access to custom input modules, and because it's a Macro-Tech, you have the added benefit of ODEP® protection to keep the show going long after other amplifiers would fail.

Modern power amplifiers are sophisticated pieces of engineering capable of producing extremely high power levels. They must be treated with respect and correctly installed if they are to provide the many years of reliable service for which they were designed.

In addition, the MA-5002VZ amplifier includes a number of features which require some explanation before they can be used to their maximum advantage.

Please take the time to study this manual so that you can obtain the best possible service from your amplifier.

1.1 Features

- *Grounded Bridge*™ design delivers large voltage swings without stressing output-transistors, resulting in lower distortion and superior reliability.
- Patented ODEP (Output Device Emulation Protection) circuitry compensates for overheating and overload to keep the amplifier working when others would fail.
- *IOC*® (Input/Output Comparator) circuitry immediately alerts of any distortion exceeding 0.05%, providing dynamic proof of distortion-free performance.
- Articulated VZ power supplies for each channel provide excellent crosstalk characteristics and the best power matching to your load.

2 How to Use This Manual

This manual provides you with the necessary information to safely and correctly setup and operate your amplifier. It does not cover every aspect of installation, setup or operation that might occur under every condition. For additional information, please consult Crown's *Amplifier Application Guide* (available online at www.crownaudio.com), Crown Technical Support, your system installer or retailer.

We strongly recommend you read all instructions, warnings and cautions contained in this manual. Also, for your protection, please send in your warranty registration card today. And save your bill of sale—it's your official proof of purchase.

3 Setup

3.1 Unpack Your Amplifier

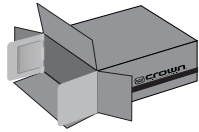

Please unpack and inspect your amplifier for any damage that may have occurred during transit. If damage is found, notify the transportation company immediately. Only you can initiate a claim for shipping damage. Crown will be happy to help as needed. Save the shipping carton as evidence of damage for the shipper's inspection.

We also recommend that you save all packing materials so you will have them if you ever need to transport the unit. **Never ship the unit without the factory pack.**

YOU WILL NEED (not supplied):

- Input wiring cables
- Output wiring cables

Rack for mounting amplifier (or a stable surface for stacking)



WARNING: Before you start to set up your amplifier, make sure you read and observe the Important Safety Instructions found at the beginning of this manual.

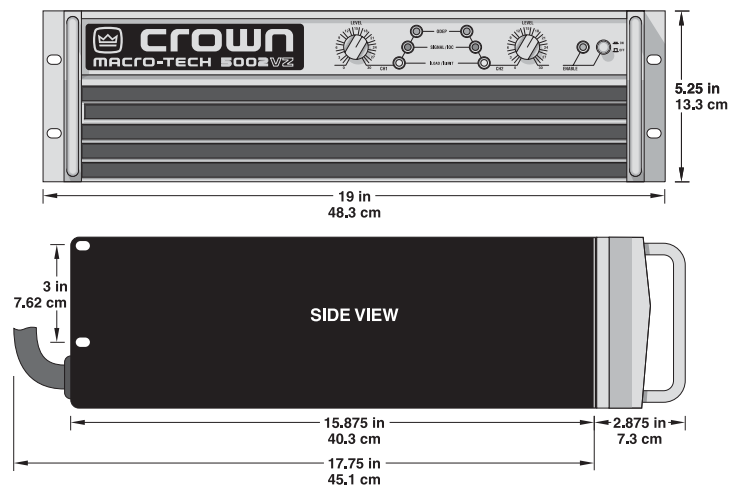

3.2 Install Your Amplifier

CAUTION: Before you begin, make sure your amplifier is disconnected from the power source, with power switch in the "off" position and all level controls turned completely down (counterclockwise).

Use a standard 19-inch (48.3 cm) equipment rack. See Figure 3.1 for amplifier dimensions.

You may also stack amps without using a cabinet.

NOTE: When transporting, amplifiers should be supported at both front and back.

3.3 Ensure Proper Cooling

When using an equipment rack, mount units directly on top of each other. Close any open spaces in rack with blank panels. DO NOT block front or rear air vents. The side walls of the rack should be a minimum of two inches (5.1 cm) away from the amplifier sides, and the back of the rack should be a minimum of four inches (10.2 cm) from the amplifier back panel.

Figure 3.2 illustrates standard amplifier airflow.



Figure 3.2 Airflow

3 Setup (continued)

3.4 Choose Input Wire and Connectors

Refer to Figure 3.3 for correct connector pin assignments for balanced wiring, and Figure 3.4 for correct connector pin assignments for unbalanced wiring.



NOTE: Custom wiring should only be performed by qualified personnel.

Balanced Line

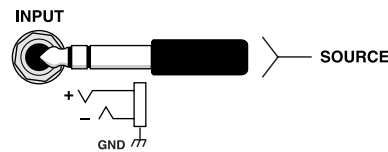
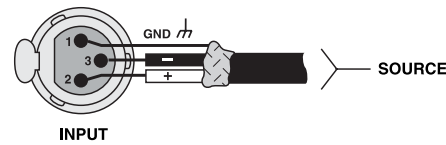

Figure 3.3 Balanced Input Connector Wiring

Unbalanced Line

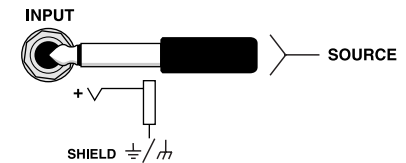
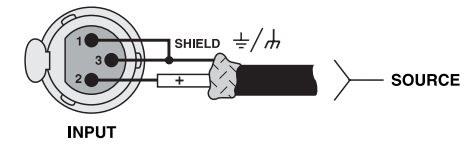

Figure 3.4 Unbalanced Input Connector Wiring

3 Setup (continued)

3.5 Choose Output Wire and Connectors

Crown recommends using pre-built or professionally wired, high-quality, two-conductor, heavy gauge speaker wire and connectors. You may use banana connectors, terminal forks or bare wire for your output connectors (see Figure 3.5). To prevent the possibility of short-circuits, wrap or otherwise insulate exposed loudspeaker cable connectors.

Using the guidelines below, select the appropriate size of wire based on the distance from amplifier to speaker.

Distance	Wire Size
up to 40 ft.	14 gauge
41-60 ft.	12 gauge
61-100 ft.	10 gauge
101-150 ft.	8 gauge
151-250 ft.	6 gauge



CAUTION: Never use shielded cable for output wiring.

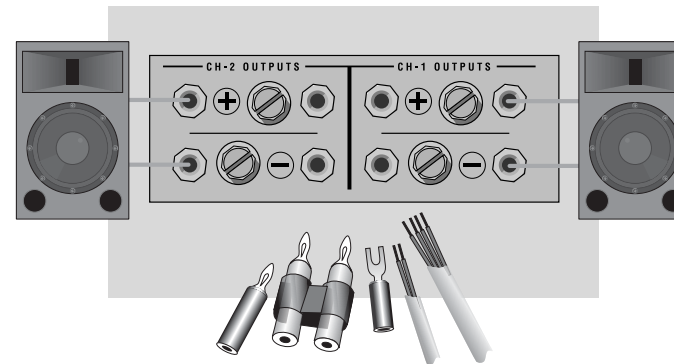

Figure 3.5 Output Connector Wiring

3 Setup (continued)

3.6 Wire Your System

3.6.1 Stereo Mode

Typical input and output wiring is shown in Figure 3.6.

INPUTS: Connect input wiring for each channel. Refer to Section 3.4 for input connector pin assignments.

OUTPUTS: Maintain proper polarity (+/-) on output connectors.

Connect positive (+) speaker lead to Channel 1 positive output of amp; connect negative (-) speaker lead to Channel 1 negative output of amp. Repeat for Channel 2. Refer to Section 3.5 for output connector pin assignments. Make sure the Mode switch is set to the "Stereo" position when operating in Stereo mode.

3.6.2 Bridge-Mono Mode

Typical input and output wiring is shown in Figure 3.7.

INPUTS: Connect input wiring to Channel 1. Refer to Section 3.4 for input connector pin assignments.

OUTPUTS: Connect positive (+) speaker lead to Channel 1 positive output of amp; connect negative (-) speaker lead to Channel 2 positive output of amp. Do not use the negative outputs when operating in Bridge-Mono mode. Refer to Section 3.5 for output connector pin assignments. Make sure the Mode switch is set to the "Bridge" position when operating in Bridge-Mono mode.

NOTE: Turn down (full CCW) the Channel 2 level control when operating in Bridge-Mono mode, as the lower-numbered level control works both channels.

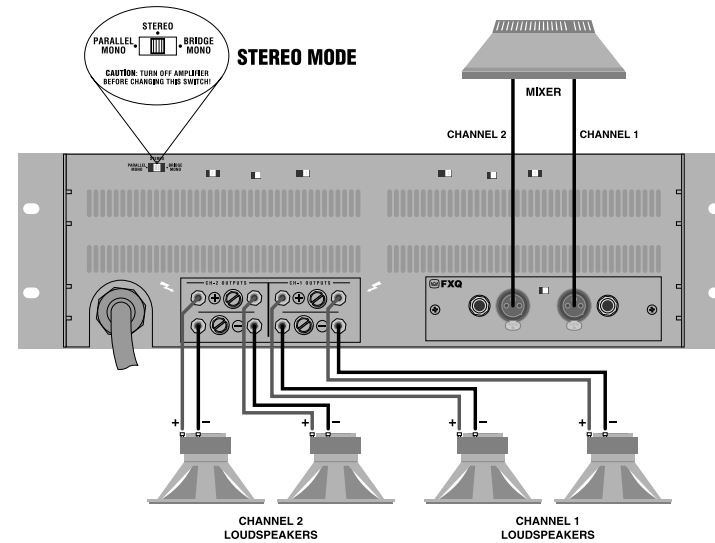

Figure 3.6 System Wiring, Stereo Mode

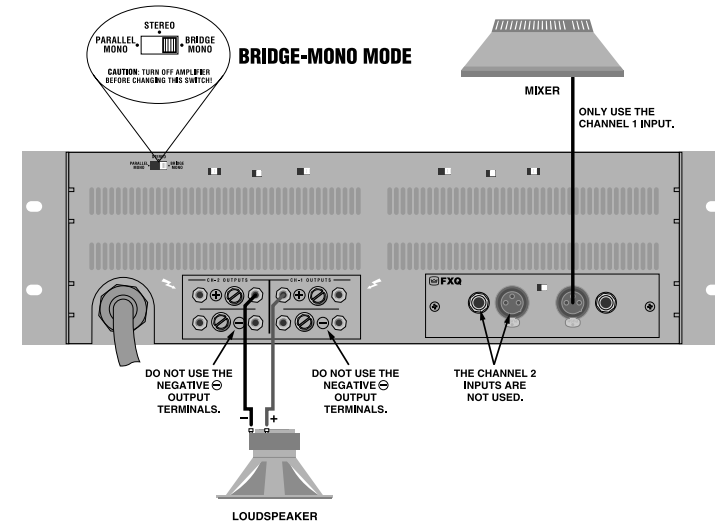

Figure 3.7 System Wiring, Bridge-Mono Mode

3 Setup (continued)

3.6.3 Parallel-Mono Mode

Typical input and output wiring is shown in Figure 3.8.

INPUTS: Connect input wiring to Channel 1. Refer to Figure 3.4 for input connector pin assignments.

OUTPUTS: Install a jumper wire between the positive outputs of both Channel 1 and Channel 2 that is at least 14 gauge in size; Connect positive (+) speaker lead to Channel 1 positive output of amp; connect negative (-) speaker lead to Channel 2 negative output of amp. Refer to Section 3.5 for output connector pin assignments. Make sure the Mode switch is set to the "Parallel" position when operating in Parallel-Mono mode.

NOTE: Turn down (full CCW) the Channel 2 level control when operating in Parallel-Mono mode, as the lower-numbered level control works both channels.



NOTE: Remove the jumper wire before changing to any mode except Parallel-Mono.

NOTE: Crown provides a reference of wiring pin assignments for commonly used connector types in the *Crown Amplifier Application Guide* available at www.crownaudio.com.

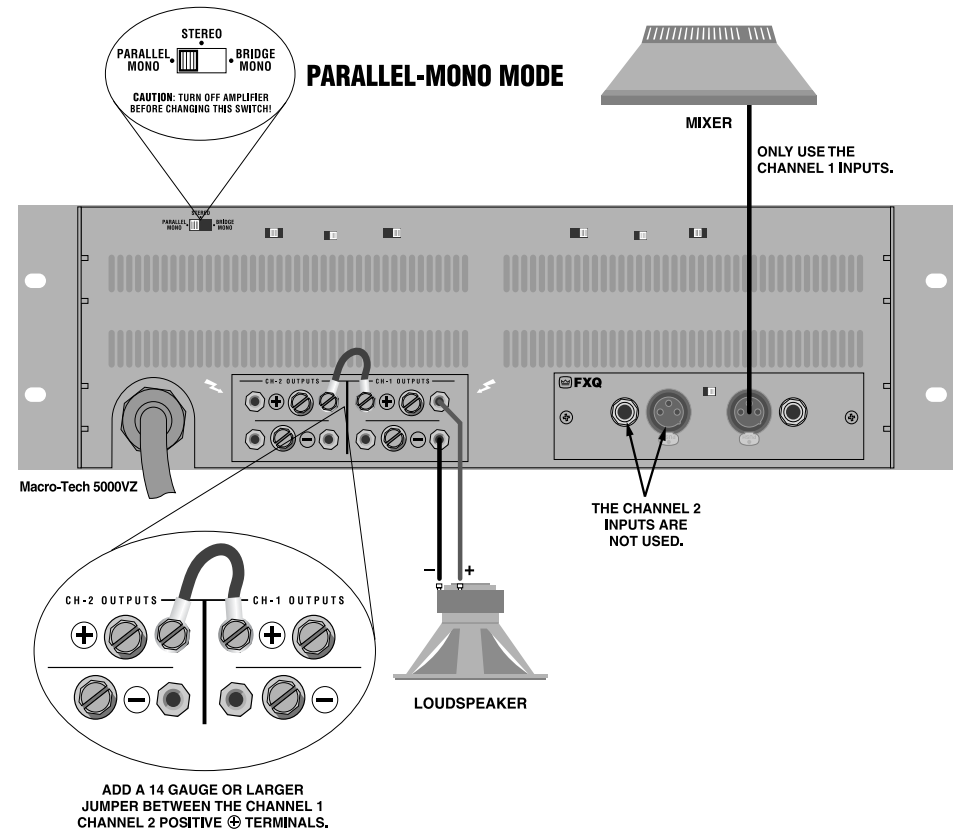

Figure 3.8 System Wiring, Parallel-Mono Mode

3 Setup (continued)

3.7 Connect to AC Mains

Connect the AC power cordset of your amplifier to the AC mains power source (power outlet).

NOTE: The plug supplied with 120V versions of the MA5000VZ is a 120V, 30-ampere plug (Figure 3.9).



Figure 3.9 120V, 30A Power Plug Supplied with 120V Versions of the MA5002VZ



NOTE: The third prong of this connector (ground) is an important safety feature. Do not attempt to disable this ground connection by using an adapter or other methods.

Amplifiers don't create energy. The AC mains voltage and current must be sufficient to deliver the power you expect. You must operate your amplifier from an AC mains power source with not more than 10% variation above or below the amplifier's specified line voltage and within the specified frequency requirements (indicated on the amplifier's back panel label). If you are unsure of the output voltage of your AC mains, please consult your electrician.

3.8 Startup Procedure

Use the following procedure when first turning on your amplifier:

1. Turn down the level of your audio source.
2. Turn down the level controls of the amplifier.
3. Turn on the "Enable" switch. The Enable indicator should glow.
4. Turn up the level of your audio source to an optimum level.
5. Turn up the Level controls on the amplifier until the desired loudness or power level is achieved.
6. Turn down the level of your audio source to its normal range.

If you ever need to make any wiring or installation changes, don't forget to turn off the amplifier and disconnect the power cord.

For help with determining your system's optimum gain structure (signal levels) please refer to the Crown Amplifier Application Guide, available online at www.crownaudio.com.

4 Operation

4.1 Precautions

Your Macro-Tech Series amplifier is protected from internal and external faults, but you should still take the following precautions for optimum performance and safety:

1. Before use, your amplifier first must be configured for proper operation, including input and output wiring hookup. Improper wiring can result in serious operating difficulties. For information on wiring and configuration, please consult the Setup section of this manual or, for advanced setup techniques, consult Crown's Amplifier Application Guide available online at www.crownaudio.com.
2. Use care when making connections, selecting signal sources and controlling the output level. The load you save may be your own!
3. Do not short the ground lead of an output cable to the input signal ground. This may form a ground loop and cause oscillations.
4. **Never connect the output to a power supply, battery or power main. Electrical shock may result.**
5. Tampering with the circuitry, or making unauthorized circuit changes, may be hazardous and invalidates all agency listings.
6. Do not operate the amplifier with the Signal/IOC LEDs constantly flashing.
7. Do not overdrive the mixer, which will cause a clipped signal to be sent to the amplifier. Such signals will be reproduced with extreme accuracy, and loudspeaker damage may result.
8. Never operate the amplifier with less than the rated load impedance. Due to the amplifier's output protection, such a configuration may result in premature clipping and speaker damage.



Remember: Crown is not liable for damage that results from overdriving other system components

4 Operation (continued)

4.2 Front Panel Controls and Indicators

A. Dust Filter

Removes large particles from the air at the air intake. The filter elements can be easily removed for cleaning by gently pulling them away from the front panel. Filters can be cleaned by soaking in a mild detergent and water.

B. Level Control

Rotary detented level control, one per channel.

C. ILoad/ILimit Indicator

Dual-color LED, one per channel. Indicator is off when there is no significant load current (extremely low or no input signal, or no load connected to the channel's output); illuminates green to indicate that load

current is flowing; and illuminates red if the amplifier has reached its maximum output current capacity. See Section 5.2.3 for more about ILoad/ILimit.

D. Signal/IOC Indicator

Green LED, one per channel. Dual-purpose indicator illuminates to indicate the presence of input signals; flashes brightly with a 0.1-second hold delay to indicate a difference (distortion) between the input and output signal of 0.05% or greater; and flashes brightly with a 0.5-second hold delay to indicate input clipping distortion. See Section 5.1.2 for more about IOC.

E. ODEP Indicator

Amber LED, one per channel, illuminates brightly to indicate presence of thermodynamic energy. They dim proportionally as

energy reserves decrease. In the event that energy reserves are depleted, the indicators turn off and ODEP limiting occurs. See Section 5.1.1 for more about ODEP.

F. Enable Indicator

Green LED indicates amplifier has been turned on and AC power is available.

G. Enable Switch

Amplifier is on when the switch is in the IN position.

H. VZ Mode Switch

Four-position switch, one Per Channel. Allows selection of "VZ-ODEP," "Lock Low," and "VZ" power supply modes, from left to right (right-most two positions both select VZ mode). See Section 5.2.2 for more about VZ and the VZ Mode Switch.

Figure 4.1 Front Panel Controls and Indicators (shown with top filter grille removed for clarity)

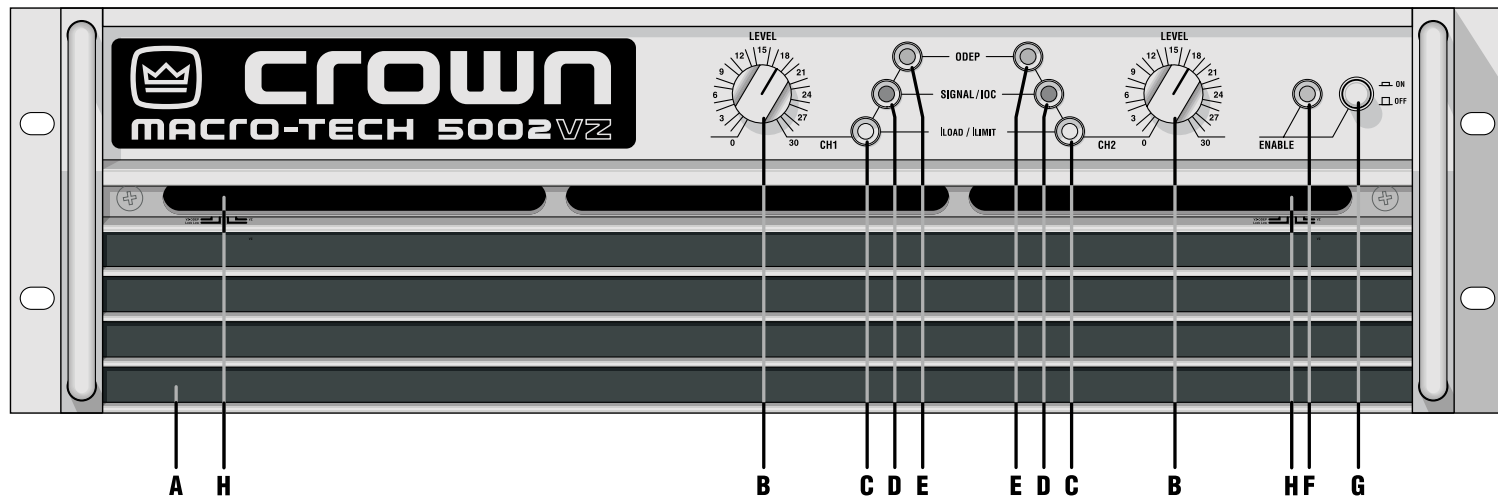

4 Operation (continued)

4.3 Back Panel Controls and Connectors

I. Stereo/Mono Switch

Allows selection of Stereo, Bridge-Mono, or Parallel-Mono operation.

J. Compressor Switch

Controls the channel's error-driven compressor. Selections include Off; Fast (4-millisecond attack, 300-millisecond release); and Slow (12-millisecond attack, 600-millisecond release).

K. Loudspeaker Offset Integration Switch

Allows the Loudspeaker Offset Integration (LOI) circuit to be enabled or disabled. See Section 5.2.4 for more info about LOI.

L. Sensitivity Switch

Three-position switch. Allows the selection of 26 dB; 1.4V; or 0.775V input sensitivity.

M. Power Cord

N. Output Connectors

High-current output block accepts banana plugs, spade lugs or bare wire. A detachable output cover, shown in Figure 4.3,

protects against accidental short circuits and dangerous electrical shock.

DANGER: The outputs can produce lethal energy levels! Do not change the output wiring unless the amplifier has been off for at least 10 seconds.



Note: Some international models include high-current binding posts rather than the output block. Figure 4.4 shows the international binding posts.

Figure 4.2 Back Panel Controls and Connectors

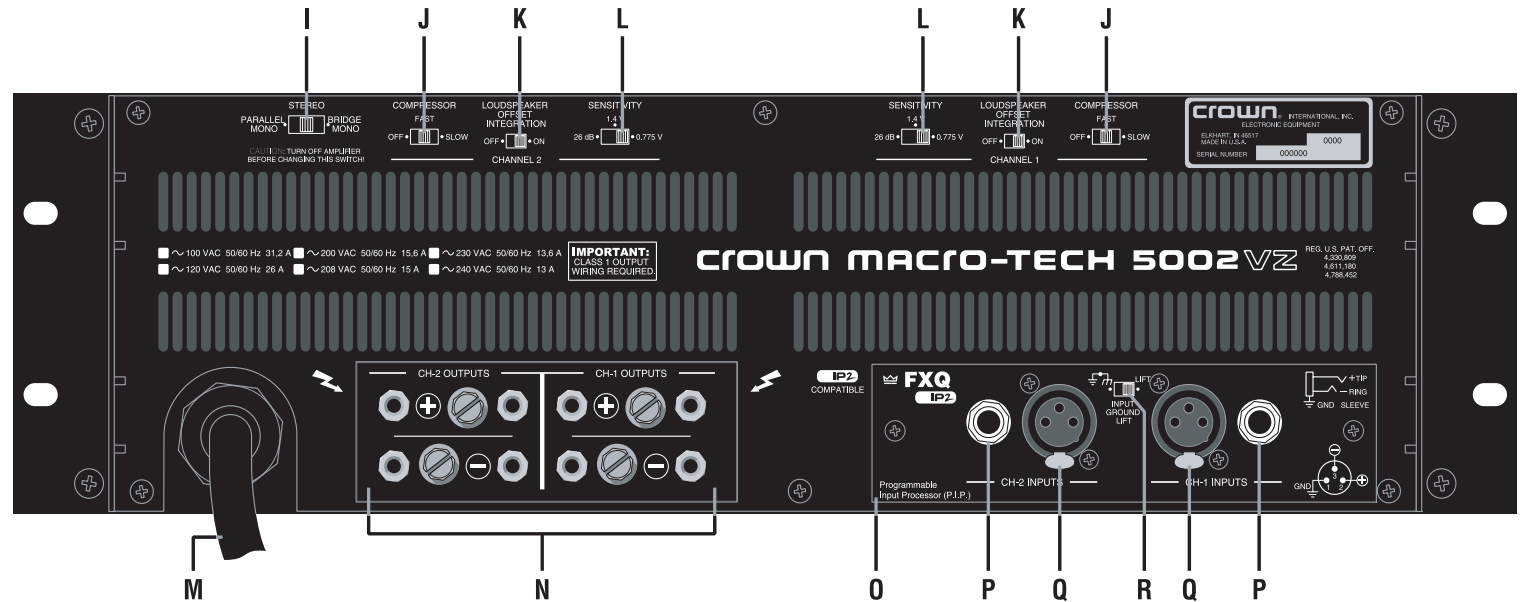

4 Operation (continued)

O. PIP2 Module

Standard module (PIP2-FXQ) provides a 3-pin female XLR connector and a female TRS jack for signal input to each channel.

P. TRS Input Jack (Standard PIP2 Module)

One per channel; female TRS input jacks are provided.

Q. XLR Inputs (Standard PIP2 Module)

One per channel, female XLR input connectors are provided.

R. Ground Lift Switch (Standard PIP2 Module)

Isolates the input signal grounds from the AC (chassis) ground to help prevent ground loops.

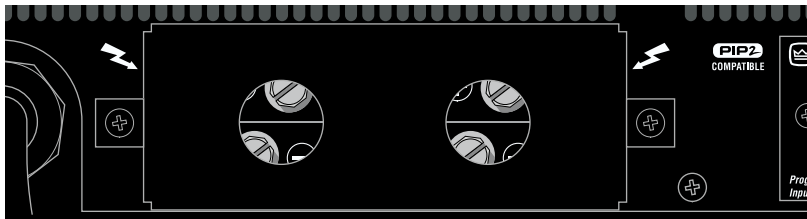

Figure 4.3 Output Cover

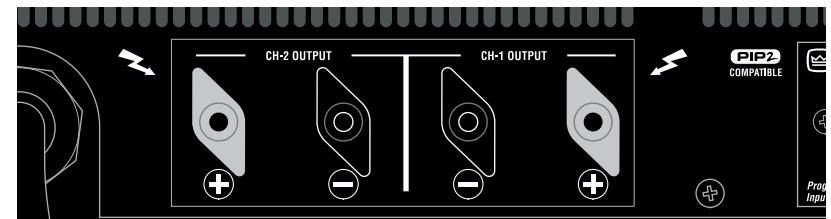

Figure 4.4 International Output Binding Posts

5 Advanced Features and Options

NOTE: For detailed information about these Crown amplifier features, please consult the Crown Amplifier Application Guide, available on the Crown website at www.crownaudio.com

5.1 Protection Systems

Your Crown amplifier provides extensive protection and diagnostic capabilities, including ODEP and IOC.

5.1.1 Output Device Emulation Protection (ODEP)

Crown invented ODEP to solve two long standing problems in amplifier design: To prevent amplifier shutdown during demanding operation and to increase the efficiency of output circuitry.

To do this, Crown established a rigorous program to measure the safe operating area (SOA) of each output transistor before installing it in an amplifier. Crown also designed intelligent circuitry to simulate the instantaneous operating conditions of those output transistors. Its name describes what it does: Output Device Emulation Protection or ODEP. It not only simulates the operation of the output transistors but it also compares their operation to their known SOA. If ODEP sees that more power is about to be asked of the output devices than they are capable of delivering under the present conditions, ODEP immediately limits the drive level until it falls within the SOA. Limiting is proportional and kept to an absolute minimum—only what is required to prevent the possibility of output transistor damage.

This level of protection enables Crown to increase output transistor utilization while greatly increasing amplifier reliability.

Finally, this onboard intelligence is monitored in two ways. First, the front panel ODEP indicators show whether the amplifier is functioning correctly or if ODEP is limiting the drive level. Second, ODEP data is fed to the PIP connector at the back of the amplifier so advanced PIP modules like the IQ-PIP-USP3 can use it to make decisions and control the amplifier.

With ODEP you get the maximum power with the maximum protection—the show goes on!

5.1.2 IOC (Input Output Comparator)

The IOC circuit compares the output signal of the amplifier with the input signal. If there is any difference other than gain, then it is considered distortion and the indicator comes on. The LED indicator will come on whenever there is distortion of 0.05% or more. An IOC condition may also be sensed by an IQ PIP module installed in PIP-compatible amplifiers.

IOC is designed to report any form of distortion. IOC not only checks the waveform for distortion, but also reports input overload and even a protective action that mutes or shuts down an amplifier. With all of these features, IOC monitors the entire amplifier. When the IOC indicator is off the amplifier is definitely operational and undistorted. IOC provides an on-line proof of performance.

5.2 Circuit Designs

5.2.1 Grounded Bridge

Grounded Bridge is the name of Crown's unique four-quadrant amplifier topology. The Grounded Bridge topology takes full advantage of the power supplies delivering peak-to-peak voltages to the load that are twice the voltage seen by the output devices and twice the voltage generated by the power supplies.

The power supply bridge rectifier is not ground referenced, and the transformer secondary is not center-tapped. This allows the power supply to deliver +VCC and -VCC from the same bridge rectifier and filter as a total difference in potential regardless of their voltages with respect to ground.

Composite output devices are arranged to function as gigantic NPN and PNP devices. Each output stage has two composite NPN and two composite PNP devices. The devices connected to the load are referred to as "high-side NPN and PNP" and the devices connected to ground are referred to as "low-side NPN and PNP." Positive current is delivered to the load by increasing conductance simultaneously in the high-side NPN and low-side PNP stage, while decreasing conductance of the high-side PNP and low-side NPN in synchrony.

Crown's Grounded Bridge design delivers large voltage swings without stressing output transistors. The results are higher efficiency, lower distortion and superior reliability.

5.2.2 Variable Impedance (VZ)

VZ is the name of Crown's patented articulated power supply technology. This innovative technology permits us to pack large amounts of power into a compact package while achieving ultra-low distortion and without generating excessive heat.

An amplifier power supply must be large enough to handle both the maximum voltage and maximum current necessary for the amplifier to drive its rated power into a specified load. In order to meet this requirement, most conventional supplies are heavy, large, and produce lots of heat. In contrast, the VZ supply gets more current AND voltage out of a smaller, lighter, and more efficient package by dynamically adapting to both signal and load requirements in real-time. This provides the best power match to the widest range of loads.

The VZ supply is divided into two segments. When the output stage requires high-voltage, the segments are arranged in series to deliver twice the voltage of a single segment. When the output stage requires high-current, the segments are arranged in parallel to deliver twice the current of a single segment. Sensing circuitry "watches" the voltage of the signal to determine when to switch VZ modes. The switching circuitry is designed to prevent audible switching distortion to yield the highest possible dynamic transfer function—you hear only the music and not the amplifier.

With VZ, you get not only maximum power and safety, but you also get the best power matching to your load.

The VZ (Variable Impedance) mode causes the power supplies to automatically shift between high-current and low-current modes of operation as operating conditions change. Normally, the power supplies operate in the high-current (low-impedance) mode for maximum thermal efficiency. When voltage demand reaches high levels, the supplies quickly shift into high-voltage (high-impedance) mode. Because voltage and current requirements vary with the output level and frequency content of the source signals, the power supplies are designed to be able to continually switch between the two modes as needed with no degradation to the audio signal.

5 Advanced Features and Options (continued)



The **VZ Mode switches** allow you to control the operation of the VZ power supply for each channel.

The VZ mode switches are located inside the amplifier behind the top dust filter on the front panel. To access these switches, remove the top filter element. **Always turn the power off before changing one of these switches.** Each switch has four settings (from left to right): **VZ-ODEP**, **Lock Low**, **VZ** and **VZ**. Note: The third and fourth positions are identical. The amplifier is shipped from the factory with the switches set to "VZ-ODEP".

The **VZ (Variable Impedance) mode** causes the power supplies to automatically shift between high-current and low-current modes of operation as operating conditions change. Normally, the power supplies operate in the high-current (low-impedance) mode for maximum thermal efficiency. When voltage demand reaches high levels, the supplies quickly shift into high-voltage (high-impedance) mode. Because voltage and current requirements vary with the output level and frequency content of the source signals, the power supplies are designed to be able to continually switch between the two modes as needed with no degradation to the audio signal.

The **VZ-ODEP mode** is very similar to VZ mode. The only difference is that the power supplies are forced into high-current mode when ODEP is close to activating its limiting circuitry. This reduces excessive stress on the output transistors, and effectively increases the thermal performance of the amplifier.

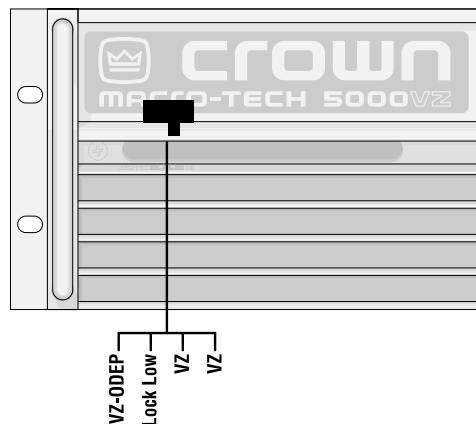

Figure 5.1 Channel 1 VZ Mode Switch (Behind Filter)

Note: When ODEP limiting begins, the IOC circuitry will see that the input waveform does not match the output waveform, and an error signal is generated. If the compressors are on, they will see the error signal and compress the input signal to correct the problem. When this happens, there is no audible signal degradation. Compression is subtle, and not noticeable unless the system is driven to extremely high levels.

The **Lock Low mode** locks the power supplies into the high-current mode for low-impedance loads. This may be desirable when driving high-frequency transducers that must be protected from too much voltage, or when driving loads with very low impedances.

5.2.3 ILoad/ILimit

The ILoad/ILimit feature is designed to help you get the maximum power out of your amplifier. In the real world, loudspeaker impedance varies with frequency, and loudspeaker impedance ratings are only approximations. Without ILoad/ILimit, you have to do some lengthy calculations to approximate the maximum number of loudspeakers you can drive with the amplifier—and this does not allow for a 4 ohm loudspeaker whose impedance drops below 2 ohms at 80 Hz.

This is why your amplifier has ILoad/ILimit. The ILoad function turns a channel's ILoad/ILimit indicator green when it senses current is flowing to the load. The ILimit function turns the indicator red when it reaches maximum current output. This makes it possible to connect real loudspeakers and conduct realistic tests to find the maximum number of loudspeakers that should be connected. To do a test like this, you can operate under worst-case conditions and continue to connect additional loudspeakers in parallel with each output until the ILoad/ILimit indicator turns red. The optimum load is achieved before the ILoad/ILimit indicator turns red, so disconnecting the last added loudspeaker gives you an optimized load.

5.2.4 Loudspeaker Offset Integration

Loudspeaker Offset Integration (LOI) circuits use double integrating filters in the amplifier's feedback circuitry to protect loudspeakers in several different ways. First, they center asymmetrical audio waveforms that cause off-center woofer cone movement. Off-center cone movement increases loudspeaker heating and distortion while reducing the loudspeaker's power handling ability. Second, LOI filters unwanted DC and subsonic frequencies using a third-order Butterworth filter with a 35 Hz corner frequency. Third, LOI filters unwanted ultrasonic frequencies (RF) that can cause tweeter burnout using a second-order Bessel filter with a 50 kHz corner frequency.



IMPORTANT: The Loudspeaker Offset Integration circuitry does NOT protect loudspeakers from large transient voltages or excessive power levels for prolonged periods of time. Crown is not liable for damage or personal injury that results from overdriving loudspeakers or other system components. For information on techniques to protect loudspeakers, refer to the *Crown Amplifier Application Guide*, available online at www.crownaudio.com.

5.3 Options

5.3.1 PIP™ Modules

Versatile PIP (Programmable Input Processor) modules provide flexible expansion features that can be added to customize the amplifier. PIP modules plug into the connector inside the back panel of the amplifier. PIP modules are available with features ranging from error-driven compressor/limiters to remote control and monitoring via System Architect or IQwic™. Your amplifier is a PIP2 amplifier, which means it can take advantage of the many advanced features found in PIP2 modules, as well as all standard PIP modules. Visit the Crown website at www.crownaudio.com, or contact Crown Customer Service, for descriptions of available PIP and PIP2 modules.

6 Troubleshooting

one or more channels			
SIGNAL/IOC	ODEP	I _{Load} /I _{Limit}	ENABLE

CONDITION: Normal operation.
POSSIBLE REASON:

- This is normal operation for your amp.

one or more channels			
SIGNAL/IOC	ODEP	I _{Load} /I _{Limit}	ENABLE

• The amp is set for Parallel Mono mode.

one or more channels			
SIGNAL/IOC	ODEP	I _{Load} /I _{Limit}	ENABLE

CONDITION: No power to the amplifier.
POSSIBLE REASON:

- The amplifier's Power switch is off.
- The amplifier is not plugged into the power receptacle.
- The amplifier's low-voltage power supply fuse has blown. Return amp to Crown or an authorized Crown Service Center for servicing.

one or more channels			
SIGNAL/IOC	ODEP	I _{Load} /I _{Limit}	ENABLE

CONDITION: Distorted sound.
POSSIBLE REASON:

- Input signal level is too high. Turn down your amplifier level controls. NOTE: Your amplifier should never be operated at a level which causes the Signal/IOC LEDs to constantly indicate an IOC condition.

SIGNAL/IOC	ODEP	I _{Load} /I _{Limit}	ENABLE

- ODEP limiting has been activated. Take appropriate measures to keep the amplifier out of ODEP limiting (see Section 5.1.1 for more information about ODEP).

SIGNAL/IOC	ODEP	I _{Load} /I _{Limit}	ENABLE

- Output current is being limited because the load impedance of the channel is too low, or the output is shorted.

one or more channels			
SIGNAL/IOC	ODEP	I _{Load} /I _{Limit}	ENABLE

CONDITION: No sound.
POSSIBLE REASON:

- The amplifier has just been turned on and is still in the 4-second turn-on delay.
- The amplifier is being held in Standby Mode by an installed IQ PIP module.
- The amplifier is in drive protection mode. This can occur with improper source signals like infrasonic square waves or input overloads that excessively clip the input signal.

SIGNAL/IOC	ODEP	I _{Load} /I _{Limit}	ENABLE

- No input signal
- Input signal level is very low.
- Level controls are turned down.

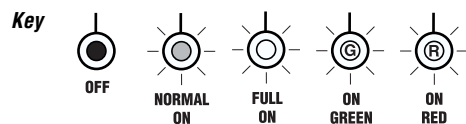

7 Specifications

Minimum Guaranteed Power (see page 20 for complete power specifications)

120 VAC, 60 Hz Units, Stereo mode, per channel, both channels driven

1 kHz with 0.1% THD

Stereo, 2 ohms per ch	2,500
Stereo, 4 ohms per ch.	2,000
Stereo, 8 ohms per ch.	1,300

120 VAC, 60 Hz Units, Bridge Mono mode

1 kHz with 0.1% THD

4 ohms	5,000
8 ohms	4,000
16 ohms	2,600

120 VAC, 60 Hz Units, Parallel Mono mode

1 kHz with 0.1% THD

1 ohm	5,000
2 ohms	3,700
4 ohms	2,600

Performance

Frequency Response

(at 1 watt, 20Hz - 20 kHz) see Figure 7.3	± 0.1 dB
---	--------------

Phase Response

(at 1 watt, 10Hz - 20 kHz) see Figure 7.6	$\pm 10^\circ$
---	----------------

Signal to Noise Ratio below full bandwidth power

20 Hz to 20 kHz	> 100 dB
A-weighted	> 105 dB

Total Harmonic Distortion (THD)

at rated power, true THD	< 0.05%
--------------------------	---------

Intermodulation Distortion (IMD)

60 Hz and 7 kHz at 4:1, from rated power to 35 dB below rated power at 8 ohms	< 0.05%
---	---------

Damping Factor

10 Hz to 400 Hz See Figure 7.4	> 1000
--------------------------------	--------

Controlled Slew Rate

> 30 volts/ μ s

Crosstalk

See Figure 7.7

Input Impedance nominally balanced, nominally unbalanced

20 k ohms, 10 k ohms

7 Specifications (continued)

Performance (continued)	
Output Impedance	See Figure 7.5
Load Impedance (Note: Safe with all types of loads)	
Stereo	2-8 ohms
Bridge Mono	4-16 ohms
Parallel Mono	1-4 ohms
Voltage Gain (8-ohm load, rated output at 1 kHz, maximum level setting)	
0.775V sensitivity	132:1 ±6% or 42 dB ±0.5 dB
1.4V sensitivity	71:1 ±6% or 37 dB ±0.5 dB
26 dB sensitivity	20:1 ±6% or 26 dB ±0.5 dB
Required AC Mains	50 or 60 Hz; 100-, 120-, 208-, 230-, 240-VAC (±10%).
Power Draw at Idle	90 watts or less
Construction	
Cooling	Internal heat sinks with on-demand, proportional forced-air cooling controlled by ODEP. Includes custom heat diffusers and patented circuitry to promote uniform dissipation.
Dimensions	
Width	EIA Standard 19-inch rack mount (EIA RS-310-B)
Height	5.25 inch (13.3 cm)
Depth (behind mounting surface)	15.875 inch (40.3 cm)
Weight	
Center of gravity is 6 inches (15.2 cm) behind the front mounting surface.	
Net	77 pounds, 9 ounces (35.2 kg)
Shipping	88 pounds, 10 ounces (40.2 kg)

7 Specifications (continued)

Macro-Tech 5002VZ – Minimum Guaranteed Power (Watts)							
AC Mains	Stereo-Mono Mode	Load (Ohms)	Maximum Average			FTC Continuous Average	
			At 0.1% THD			At 0.1% THD	
			1 kHz	20Hz-20kHz	1 kHz	1 kHz	20Hz-20kHz
120 VAC, 60 Hz	Stereo (both channels driven)	2	2500	2155	2325		
		4	2000	1775	1995	1865	
		8	1300	1090	1295	1295	1030
	Bridge-Mono (balanced output)	4	5000		4875		
		8	4000	3670	3970	3790	
		16	2600	1875	2550	2570	2035
	Parallel-Mono	1	5000		4945		
		2	3700		3700	3790	
		4	2600		2570	2580	
100 VAC, 50 Hz	Stereo (both channels driven)	2	2375		2340		
		4	1865	1740	1835	1770	
		8	1250	1065	1235	1230	1015
	Bridge-Mono (balanced output)	4	4725		4670		
		8	3700	3355	3650	3635	
		16	2490	2120	2425	2455	2015
	Parallel-Mono	1	4695		4630		
		2	3730		3675	3470	
		4	2490		2465	2455	
230 VAC, 50 Hz	Stereo (both channels driven)	2	2525		2430		
		4	1985	1760	1965		
		8	1310	1070	1285	1240	1015
	Bridge-Mono (balanced output)	4	5070		5025		
		8	3935	3525	3910		
		16	2645	2150	2600	2605	1985
	Parallel-Mono	1	5085		5025		
		2	3960		3920		
		4	2635		2615	2605	

Figure 7.1 Minimum Power Matrix

Macro-Tech 5002VZ – Maximum Power (Watts)										
AC Mains	Stereo-Mono Mode	Load (Ohms)	Single Cycle Tone Burst				40 Millisecond Tone Burst			
			At less than 0.05% THD				At 0.05% THD			
			20 Hz	50 Hz	1 kHz	7 kHz	50 Hz	1 kHz	7 kHz	
120 VAC, 60 Hz	Stereo (both channels driven)	2	2285	3070	3195	2460	2825	2505	2440	
		4	1820	2310	3220	1530	2100	1940	1510	
		8	1305	1440	1760		1330	1270	870	
	Bridge-Mono (balanced output)	4	4905	6400	6605	4815	5750	5320	4815	
		8	4280	5035	6780	3135	4455	4070	3100	
		16	2770	3000	3695		2770	2670	1815	
	Parallel-Mono	1	4910	6765	6925	4550	5925	5285	4505	
		2	3885	5005	6740	2975	4425	4045	2975	
		4	2720	3025	3660		2770	2670	1795	
	100 VAC, 50 Hz	Stereo (both channels driven)	2	2305	3040	3085	2060	2870	2415	2040
			4	1835	2380	3305	1280	2080	1895	1280
			8	1245	1470	1800		1340	1265	740
Bridge-Mono (balanced output)		4	4635	6030	6125	3985	5935	4845	3945	
		8	3685	4820	6670	2540	4255	3805	2540	
		16	2495	2940	3620		2740	2545	1485	
Parallel-Mono		1	4600	6300	6455	4090	5705	4865	4050	
		2	3660	4785	6615	2560	4310	3820	2560	
		4	2490	2990	3595		2685	2565	1515	
230 VAC, 50 Hz		Stereo (both channels driven)	2	2350	2930	3000	2125	2905	2545	2125
			4	1845	2380	3205	1300	2210	1925	1300
			8	1235	1425	1740		1365	1270	740
	Bridge-Mono (balanced output)	4	4995	6060	6155	4155	6060	5310	4155	
		8	3900	5065	6695	2615	4615	4060	2615	
		16	2590	2995	3655		2865	2665	1535	
	Parallel-Mono	1	4865	6250	6450	4345	6145	5275	4305	
		2	3865	4930	6635	2690	4485	4025	2690	
		4	2570	3025	3630		2795	2670	1560	

Figure 7.2 Maximum Power Matrix

7 Specifications (continued)

Figure 7.3 Typical Frequency Response

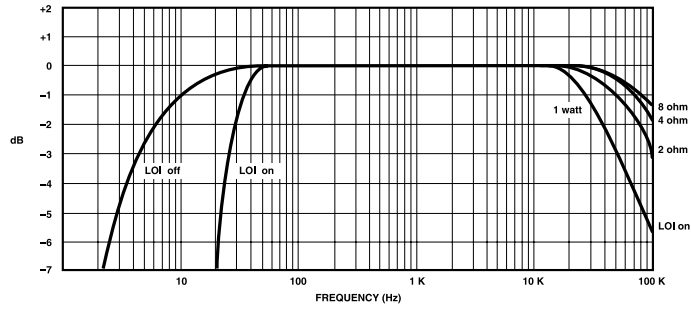

Figure 7.6 Typical Phase Response

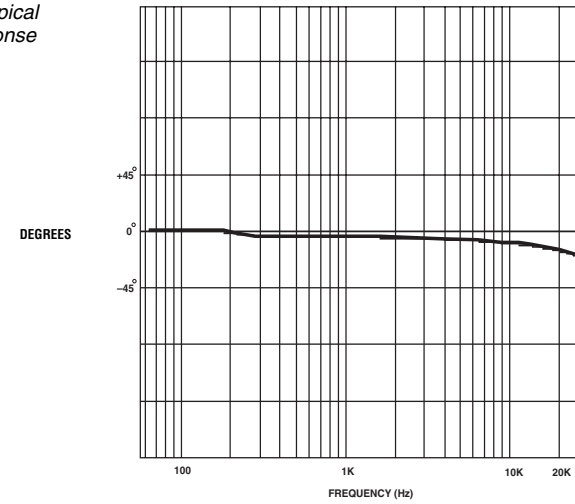

Figure 7.4 Typical Damping Factor

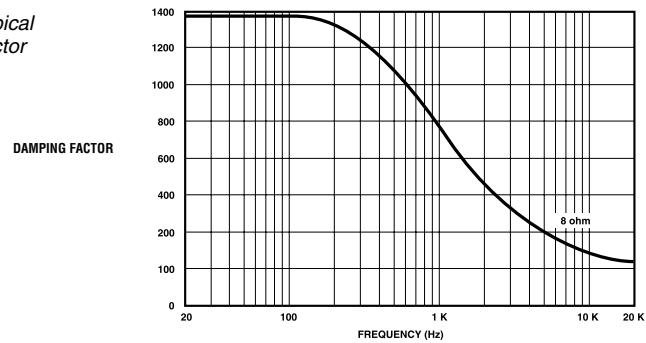

Figure 7.7 Typical Crosstalk

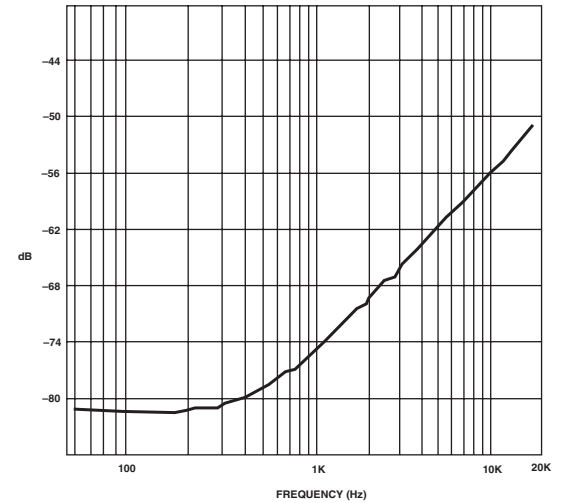
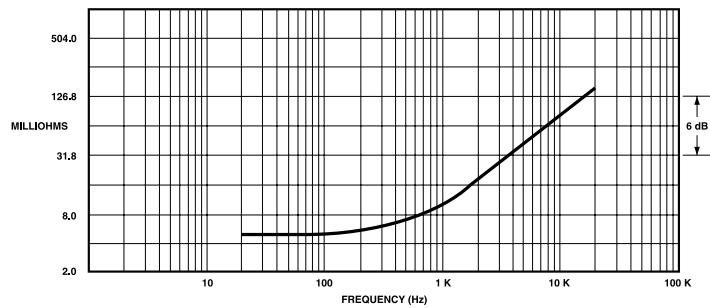

Figure 7.5 Typical Output Impedance



8 Service

Crown amplifiers are quality units that rarely require servicing. Before returning your unit for service, please contact Crown Technical Support to verify the need for servicing.

This unit has very sophisticated circuitry which should only be serviced by a fully trained technician. This is one reason why each unit bears the following label:

CAUTION: To prevent electric shock, do not remove covers. No user serviceable parts inside. Refer servicing to a qualified technician.



Complete the Crown Audio Factory Service Information form, in the back of this manual, when returning a Crown product to the factory or authorized service center. The form must be included with your product inside the box or in a packing slip envelope securely attached to the outside of the shipping carton. Do not send this form separately.

Warranty is only valid within the country in which the product is purchased.

8.1 International and Canada Service

Service may be obtained from an authorized service center. (Contact your local Crown/Amcron representative or our office for a list of authorized service centers.) To obtain service, simply present the bill of sale as proof of purchase along with the defective unit to an authorized service center. They will handle the necessary paperwork and repair.

Remember to transport your unit in the original factory pack.

8.2 US Service

Service may be obtained in one of two ways: from an authorized service center or from the factory. You may choose either. It is important that you have your copy of the bill of sale as your proof of purchase.

8.2.1 Service at a US Service Center

This method usually saves the most time and effort. Simply present your bill of sale along with the defective unit to an authorized service center to obtain service. They will handle the necessary paperwork and repair. Remember to transport the unit in the original factory pack. A list

of authorized service centers in your area can be obtained from Crown Factory Service, or online from <http://www.crownaudio.com/support/servcent.htm>.

8.2.2 Factory Service

Crown accepts no responsibility for non-serviceable product that is sent to us for factory repair. It is the owner's responsibility to ensure that their product is serviceable prior to sending it to the factory. Serviceable product list is available at <http://crownweb.crownintl.com/crownrma/>. For more information, please contact us direct.

A Service Return Authorization (SRA) is required for product being sent to the factory for repair. An SRA can be completed online at www.crownaudio.com/support/factserv.htm. If you do not have access to the web, please call Crown's Customer Service at 574.294.8200 or 800.342.6939 extension 8205.

For warranty service, we will pay for ground shipping both ways in the United States. Contact Crown Customer Service to obtain prepaid shipping labels prior to sending the unit. Or, if you prefer, you may prepay the cost of shipping, and Crown will reimburse you. Send copies of the shipping receipts to Crown to receive reimbursement. Your repaired unit will be returned via UPS ground. Please contact us if other arrangements are required.

8.2.3 Factory Service Shipping Instructions:

1. Service Return Authorization (SRA) is required for product being sent to the factory for service. Please complete the SRA by going to www.crownaudio.com/support/factserv.htm. If you do not have access to our website, call 1.800.342.6939, extension 8205 and we'll create the SRA for you.
2. See packing instructions that follow.
3. Ship product to:
CROWN AUDIO FACTORY SERVICE
1718 W MISHAWKA RD.
ELKHART, IN 46517
4. Use a bold black marker and write the SRA number on three sides of the box.

5. Record the SRA number for future reference. The SRA number can be used to check the repair status.

8.2.4 Packing Instructions

Important: These instructions must be followed. If they are not followed, Crown Audio, Inc. assumes no responsibility for damaged goods and/or accessories that are sent with your unit.

1. Fill out and include the Crown Audio Factory Service Information sheet in the back of this manual.
2. Do not ship any accessories (manuals, cords, hardware, etc.) with your unit. These items are not needed to service your product. We will not be responsible for these items.
3. When shipping your Crown product, it is important that it has adequate protection. We recommend you use the original pack material when returning the product for repair. If you do not have the original box, please call Crown at 800.342.6939 or 574.294.8210 and order new pack material. See instructions for "foam-in-place" shipping pack. (Do not ship your unit in a wood or metal cabinet.)
4. If you provide your own shipping pack, the minimum recommended requirements for materials are as follows:
 - a. 275 P.S.I. burst test, Double-Wall carton that allows for 2-inch solid Styrofoam on all six sides of unit or 3 inches of plastic bubble wrap on all six sides of unit.
 - b. Securely seal the package with an adequate carton sealing tape.
 - c. Do not use light boxes or "peanuts". Damage caused by poor packaging will not be covered under warranty.

Using your 'foam-in-place' shipping pack

Note: The foam-in-place packing is molded so that there is only one correct position for your product.

1. Open carton and lift center cushion leaving both end-cushions in place.

2. Carefully place your product with the product's front panel facing the same direction as arrows indicate.
3. Reset center cushion down over top of product's chassis. The foam-in-place packing was molded to accommodate different chassis depth sizes. If your product's chassis does not completely fill the foam-in-place cavity, you may use a soft but solid packing material (such as paper or bubble wrap) behind the chassis.
4. Enclose the completed Crown Audio Factory Service Information form (or securely attach it to the outside of carton) and re-seal the shipping pack with a sturdy carton sealing tape.

8.2.5 Estimate Approval

Approval of estimate must be given within 30 days after being notified by Crown Audio Inc. Units still in the possession of Crown after 30 days of the estimate will become the property of Crown Audio Inc.

8.2.6 Payment of Non-Warranty Repairs

Payment on out-of-warranty repairs must be received within 30 days of the repair date. Units unclaimed after 30 days become the property of Crown Audio Inc.

If you have any questions, please contact Crown Factory Service.

Crown Factory Service
1718 W. Mishawaka Rd.,
Elkhart, Indiana 46517 U.S.A.

Telephone:
574.294.8200
800.342.6939 (North America,
Puerto Rico, and Virgin Islands only)

Facsimile:
574.294.8301 (Technical Support)
574.294.8124 (Factory Service)

Internet:
<http://www.crownaudio.com>

9 Warranty



UNITED STATES & CANADA

SUMMARY OF WARRANTY

Crown International, 1718 West Mishawaka Road, Elkhart, Indiana 46517-4095 U.S.A. warrants to you, the ORIGINAL PURCHASER and ANY SUBSEQUENT OWNER of each NEW Crown product, for a period of three (3) years from the date of purchase by the original purchaser (the "warranty period") that the new Crown product is free of defects in materials and workmanship. We further warrant the new Crown product regardless of the reason for failure, except as excluded in this Warranty.

Warranty is only valid within the country in which the product was purchased.

ITEMS EXCLUDED FROM THIS CROWN WARRANTY

This Crown Warranty is in effect only for failure of a new Crown product which occurred within the Warranty Period. It does not cover any product which has been damaged because of any intentional misuse, accident, negligence, or loss which is covered under any of your insurance contracts. This Crown Warranty also does not extend to the new Crown product if the serial number has been defaced, altered, or removed.

WHAT THE WARRANTOR WILL DO

We will remedy any defect, regardless of the reason for failure (except as excluded), by repair, replacement, or refund. We may not elect refund unless you agree, or unless we are unable to provide replacement, and repair is not practical or cannot be timely made. If a refund is elected, then you must make the defective or malfunctioning product available to us free and clear of all liens or other encumbrances. The refund will be equal

to the actual purchase price, not including interest, insurance, closing costs, and other finance charges less a reasonable depreciation on the product from the date of original purchase. Warranty work can only be performed at our authorized service centers or at the factory. Warranty work for some products can only be performed at our factory. We will remedy the defect and ship the product from the service center or our factory within a reasonable time after receipt of the defective product at our authorized service center or our factory. All expenses in remedying the defect, including surface shipping costs in the United States, will be borne by us. (You must bear the expense of shipping the product between any foreign country and the port of entry in the United States including the return shipment, and all taxes, duties, and other customs fees for such foreign shipments.)

HOW TO OBTAIN WARRANTY SERVICE

You must notify us of your need for warranty service within the warranty period. All components must be shipped in a factory pack, which, if needed, may be obtained from us free of charge. Corrective action will be taken within a reasonable time of the date of receipt of the defective product by us or our authorized service center. If the repairs made by us or our authorized service center are not satisfactory, notify us or our authorized service center immediately.

DISCLAIMER OF CONSEQUENTIAL AND INCIDENTAL DAMAGES

YOU ARE NOT ENTITLED TO RECOVER FROM US ANY INCIDENTAL DAMAGES RESULTING FROM ANY DEFECT IN THE NEW CROWN

PRODUCT. THIS INCLUDES ANY DAMAGE TO ANOTHER PRODUCT OR PRODUCTS RESULTING FROM SUCH A DEFECT. SOME STATES DO NOT ALLOW THE EXCLUSION OR LIMITATIONS OF INCIDENTAL OR CONSEQUENTIAL DAMAGES, SO THE ABOVE LIMITATION OR EXCLUSION MAY NOT APPLY TO YOU.

WARRANTY ALTERATIONS

No person has the authority to enlarge, amend, or modify this Crown Warranty. This Crown Warranty is not extended by the length of time which you are deprived of the use of the new Crown product. Repairs and replacement parts provided under the terms of this Crown Warranty shall carry only the unexpired portion of this Crown Warranty.

DESIGN CHANGES

We reserve the right to change the design of any product from time to time without notice and with no obligation to make corresponding changes in products previously manufactured.

LEGAL REMEDIES OF PURCHASER

THIS CROWN WARRANTY GIVES YOU SPECIFIC LEGAL RIGHTS, YOU MAY ALSO HAVE OTHER RIGHTS WHICH VARY FROM STATE TO STATE. No action to enforce this Crown Warranty shall be commenced after expiration of the warranty period.

THIS STATEMENT OF WARRANTY SUPERSEDES ANY OTHERS CONTAINED IN THIS MANUAL FOR CROWN PRODUCTS. 9/07

9 Warranty (continued)

WORLDWIDE EXCEPT USA & CANADA



SUMMARY OF WARRANTY

Crown International, 1718 West Mishawaka Road, Elkhart, Indiana 46517-4095 U.S.A. warrants to you, the ORIGINAL PURCHASER and ANY SUBSEQUENT OWNER of each NEW Crown1 product, for a period of three (3) years from the date of purchase by the original purchaser (the "warranty period") that the new Crown product is free of defects in materials and workmanship, and we further warrant the new Crown product regardless of the reason for failure, except as excluded in this Warranty.

Warranty is only valid within the country in which the product is purchased.

1 Note: If your unit bears the name "Amcron," please substitute it for the name "Crown" in this warranty.

ITEMS EXCLUDED FROM THIS CROWN-WARRANTY

This Crown Warranty is in effect only for failure of a new Crown product which occurred within the Warranty Period. It does not cover any product which has been damaged because of any intentional misuse, accident, negligence, or loss which is covered under any of your insurance contracts. This Crown Warranty also does not extend to the new Crown product if the serial number has been defaced, altered, or removed.

WHAT THE WARRANTOR WILL DO

We will remedy any defect, regardless of the reason for failure (except as excluded), by repair, replacement, or refund. We may not elect refund unless you agree, or unless we are unable to provide replacement, and repair is not practical or cannot be timely made. If a refund is elected, then you must make the defective or malfunctioning product available to us free and clear of all liens or other encumbrances. The refund will be equal to the actual purchase price, not including interest, insurance, closing costs, and other finance charges less a reasonable depreciation on the product from the date of original purchase. Warranty work can only be performed at our authorized service centers. We will remedy the defect and ship the product from the service center within a reasonable time after receipt of the defective product at our authorized service center.

HOW TO OBTAIN WARRANTY SERVICE

You must notify your local Crown importer of your need for warranty service within the warranty period. All components must be shipped in the original box. Corrective action will be taken within a reasonable time of the date of receipt of the defective product by our authorized service center. If the repairs made by our authorized service center are not satisfactory, notify our authorized service center immediately.

DISCLAIMER OF CONSEQUENTIAL AND INCIDENTAL DAMAGES

YOU ARE NOT ENTITLED TO RECOVER FROM US ANY INCIDENTAL DAMAGES RESULTING FROM ANY DEFECT IN THE NEW CROWN PRODUCT. THIS INCLUDES ANY DAMAGE TO ANOTHER PRODUCT OR PRODUCTS RESULTING FROM SUCH A DEFECT.

WARRANTY ALTERATIONS

No person has the authority to enlarge, amend, or modify this Crown Warranty. This Crown Warranty is not extended by the length of time which you are deprived of the use of the new Crown product. Repairs and replacement parts provided under the terms of this Crown Warranty shall carry only the unexpired portion of this Crown Warranty.

DESIGN CHANGES

We reserve the right to change the design of any product from time to time without notice and with no obligation to make corresponding changes in products previously manufactured.

LEGAL REMEDIES OF PURCHASER

No action to enforce this Crown Warranty shall be commenced after expiration of the warranty period.

THIS STATEMENT OF WARRANTY SUPERSEDES ANY OTHERS CONTAINED IN THIS MANUAL FOR CROWN PRODUCTS. 9/07



CROWN

PRODUCT REGISTRATION

Crown Audio, Inc.
 1718 W. Mishawaka Rd.
 Elkhart, IN 46517-9439
 Phone: 574-294-8000
 Fax: 574-294-8329
 www.crownaudio.com

Online registration is also available at <http://crownweb.crownintl.com/webregistration>.

Warranty is only valid within the country in which the product is purchased.

When this form is used to register your product, it may be mailed or faxed.

Crown Audio, Inc. Fax: 574-294-8329
 1718 W Mishawaka Rd
 Elkhart IN 46517

Please note that some information is required. Incomplete registrations will not be processed. * Indicates required information.

OWNER'S INFORMATION - PLEASE PRINT

* First name: _____ Middle initial: _____ * Last name: _____
 Company: _____
 * Mailing address: _____
 * City: _____ * State: _____ * Zip Code: _____
 * Country: _____ E-mail address: _____
 * Phone # (include area code): _____ Fax #: _____

PRODUCT INFORMATION

* MODEL	* SERIAL #	* PURCHASE DATE
e.g. IT8000, CDi1000, PCC160	e.g. 8000000000	mo/day/yr
_____	_____	____/____/____
_____	_____	____/____/____
_____	_____	____/____/____
_____	_____	____/____/____

Product purchased from: *(Business/Individual) _____ Country: _____

Comments: _____

CUT ON THIS LINE

THIS PAGE INTENTIONALLY LEFT BLANK.



Crown Audio Factory Service Information

Shipping Address: Crown Audio Factory Service, 1718 W. Mishawaka Rd., Elkhart, IN 46517

PLEASE PRINT CLEARLY

SRA #: _____ (If sending product to Crown factory service.) Model: _____ Serial Number: _____ Purchase Date: _____

PRODUCT RETURN INFORMATION

Individual or Business Name: _____

Phone #: _____ Fax #: _____ E-Mail: _____

Street Address (please, no P.O. Boxes): _____

City: _____ State/Prov: _____ Postal Code: _____ Country: _____

Nature of problem: _____

Other equipment in your system: _____

If warranty is expired, please provide method of payment. Proof of purchase may be required to validate warranty.

PAYMENT OPTIONS

I have open account payment terms. Purchase order required. PO# _____ COD

Credit Card (Information below is required; however if you do not want to provide this information at this time, we will contact you for the information when your unit is repaired).

Credit card information:

Type of credit card: Master Card Visa American Express Discover

Type of credit card account: Personal/Consumer Business/Corporate

Card # _____ Exp. date: _____ * Card ID #: _____

* Card ID # is located on the back of the card following the credit card #, in the signature area. On American Express, it may be located on the front of the card. This number is required to process the charge to your account. If you do not want to provide it at this time, we will call you to obtain this number when the repair of your unit is complete.

Name on credit card: _____

Billing address of credit card: _____



H A Harman International Company