

XR250

S P O T

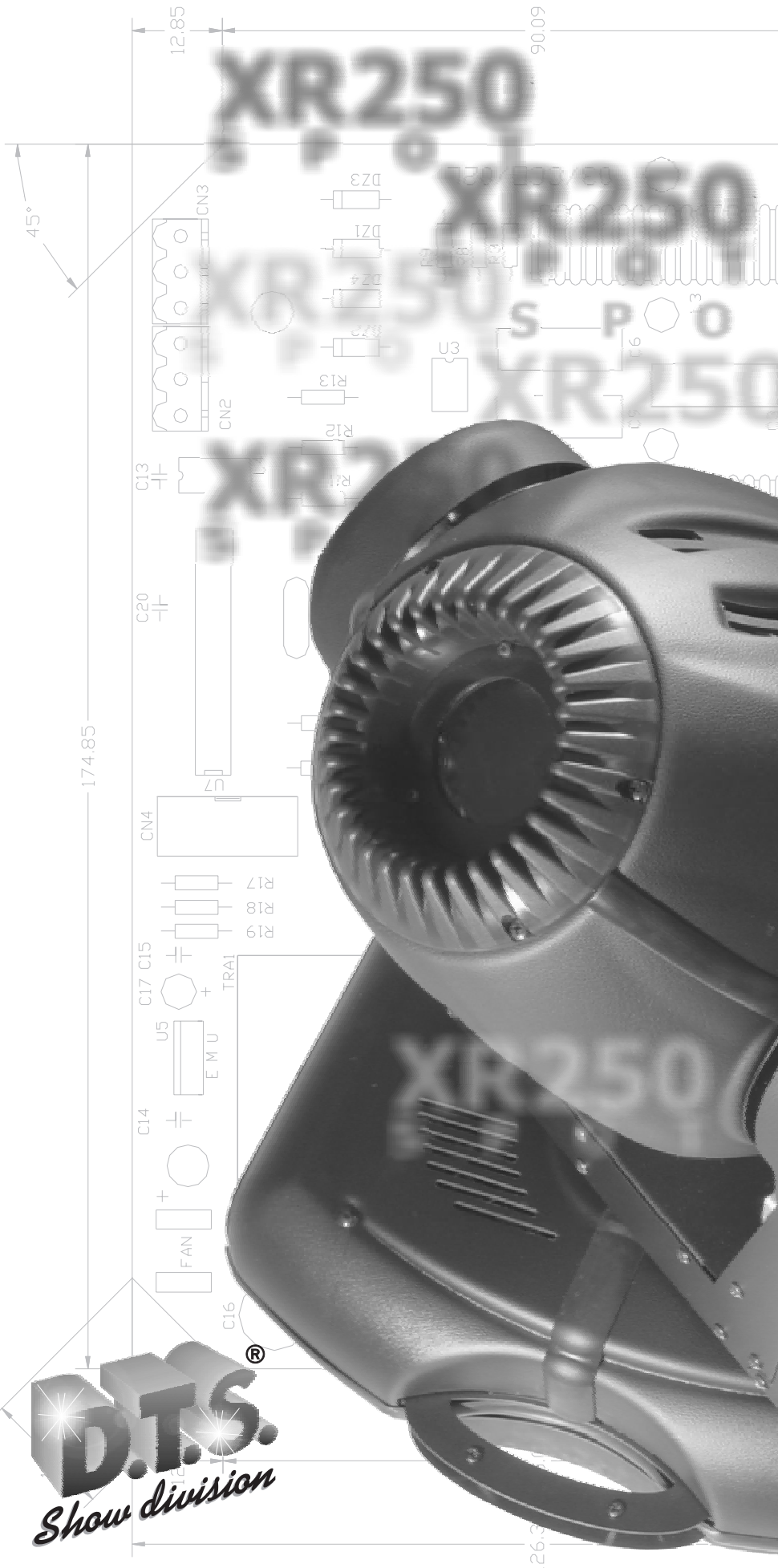

XR250

S P O T

ENG

XR250

S P O T

D.T.S.
Show division

1728

1- TECHNICAL FEATURES	Pg. 1
2- IMPORTANT SAFETY INFORMATION	Pg. 2
2.1 Fire prevention	
2.2 Prevention of electric shock	
2.3 Protection against ultraviolet radiation	
2.4 Safety	
2.5 Level of protection against the penetration of solid and liquid matter	
3- MOUNTING THE LAMP	Pg. 3
3.1 Lamp alignment	
4- VOLTAGE AND FREQUENCY	Pg. 4
5- INSTALLATION	Pg. 4
5.1 Safety chain	
5.2 Protection against liquids	
5.3 Movement	
5.4 Risk of fire	
5.5 Forced ventilation	
5.6 Ambient temperature	
6- MAINS CONNECTION	Pg. 5
6.1 Protection	
7- DMX SIGNAL CONNECTION	Pg. 6
8- DMX ADDRESSES	Pg. 7
8.1 Changing the DMX addresses	
9- DISPLAY	Pg. 8
10- DISPLAY FUNCTIONS	Pg. 8
10.1 Automatic operation	
10.2 Pan & Tilt speed (SPEE) (default: 2)	
10.3 Fan speed (FANS) (default: 6)	
11- ERROR MESSAGES	Pg. 11
12- HIDDEN MENU	Pg. 12
13- OPENING UP THE PROJECTOR HOUSING	Pg. 13
14- REPLACING THE GOBOS	Pg. 13
15- PERIODIC CLEANING & CONTROLS	Pg. 14
15.1 Lenses and raylight reflectors	
15.4 Fans and air passages	
15.3 Lamp	
15.4 Mechanical parts	
15.5 Electrical components	
15.6 Fuse replacement	
15.7 Warnings	
16- WIRING CONNECTIONS	Pg.23
17- DMX SIGNAL FUNCTION	Pg. 15

1- TECHNICAL FEATURES

- ABS cover
- Lamp MSD250/2
- Control: max 14 channels DMX
- Fast, silent and precise movement
- Position controlled pan (540°) and tilt (320°) by encoder
- 7 rotating and indexable gobos + open
- Colour wheel with 6 dichroic high chromatic yield filters + white
- Motorized focus
- Light fixed beam angel fixed at 13° (on request can be set to 18° or 21°)
- Mechanical dimmer
- Strobe effect
- Prism effect
- Possibility to function autonomously
- Weight: 20 Kg.



2- IMPORTANT SAFETY INFORMATION

2.1 Fire prevention:

- 1. XR250SPOT uses a Philips MSD250/2 . The use of any alternative lamp is not recommended and will null and void the fixture's warranty.**
- 2. Never locate the fixture on any flammable surface.**
- 3. Minimum distance from flammable materials: 0.5 m.**
- 4. Minimum distance from the closest illuminable surface: 2 m.**
- 5. Replace any blown or damaged fuses only with those of identical value. Refer to the wiring diagram if there is any doubt.**
- 6. Connect the projector to mains power via a thermal magnetic circuit breaker.**

2.2 Prevention of electric shock:

- High voltage is present inside the unit. Isolate the projector from the mains supply prior to performing any function which involves touching the inside of the unit, including lamp replacement.**
- The level of technology inherent in the XR250SPOT requires the assistance of specialised personnel for all servicing. Refer all work to your authorised DTS service centre.**
- A good earth connection is essential for proper functioning of the projector. Never connect the unit without proper earth connection.**
- The fixture should never be located in a position exposed to rain or in areas of extreme humidity. A steady supply of circulating air is essential.**

2.3 Protection against ultraviolet radiation:

- 1. Never turn the lamp on if any of the lenses, filters or the carbon fibre housing is damaged. Their respective shielding functions will only operate efficiently if they are in perfect working order.**
- 2. Never look directly into the lamp when it is on.**

2.4 Safety:

- The projector should always be installed with bolts, clamps and other fixtures that are capable of supporting the weight of the unit.**
 - Always use a second safety chain of a suitable rating to sustain the weight of the unit in case of the failure of the main fixing point.**
 - The external surface of the unit, at various points, may exceed 150°C. Never handle the unit until at least 10 minutes have elapsed since the lamp was turned off.**
 - Always replace the lamp if any physical damage is evident.**
 - Never install the fixture in an enclosed area lacking sufficient air flow. The ambient temperature should not exceed 35°C.**
 - A hot lamp may explode, so always wait for at least 10 minutes to elapse after the unit has been turned off prior to attempting to replace the lamp.**
- Always wear suitable hand protection when handling the lamp.**

2.5 Level of protection against the penetration of solid and liquid matter

- The projector is classified as an ordinary appliance and its level of protection against the penetration of solid and liquid matter is IP 20. XR250SPOT uses MSD250/2 Philips lamps with GY 9.5 base.**

The temperature inside the projector can reach 150° C after just 5 minutes, but it can get as high as 350° C. Always check that the lamp is cold before attempting to remove it. In any case, only open the appliance 10 minutes after it has been turned off.

3- MOUNTING THE LAMP

Warning: turn power off before opening the appliance.

Philips MSD250/2

Power 250W

Luminous flux 18.000 lm

Colour temperature 8500°K

Lampbase GY9.5

Rated life 2.000 hours

1) Using a PHILIPS screwdriver, remove the 3 screws (X,Y, Z) (photo 1, black screws) which hold the lampholder in place and are located at the rear of the projector head.



Photo 1



Photo 2



Photo 3

2) Remove the lampholder unit. Locate the lampholder (photo 2).

3) Insert the lamp (photo 3)

The lamp used is manufactured from quartz glass and should be handled with care. Always adhere to the instructions supplied in the lamp's packaging. Never touch the glass directly but use the tissue provided in the lamp's packaging. The GY 9.5 lampbase is not symmetrical.

DO NOT USE UNDUE FORCE ON THE GLASS. In case of difficulty, re-read the instructions and repeat the procedure.

4) Replace the lamp assembly (photo 4) and replace and tighten the screws (X,Y,Z), which were previously removed (photo 1).

3.1 Lamp alignment

Attention: we recommend that the lamp be realigned in the optical train of the unit to avoid overheating of the dichroic filters and other components inside the unit. (Photo 5).



Photo 5

Alignment is carried out using the 3 adjusters A, B and C (white screws).

During this operation you must bring the hot-spot to the centre of the beam and flatten

it as much as possible.

4- VOLTAGE AND FREQUENCY

The projector can operate at 230V voltage, at 50 or 60 Hz. D.T.S. presets a voltage of 230V at a frequency of 50Hz (barring specific requests).

5- INSTALLATION

XR250SPOT may be either floor or ceiling mounted.

For floor mounting installations, the XR250SPOT is supplied with four rubber mounting feet (B) on the base.

For ceiling mounted installations, we suggest the use of appropriate clamps or fixings to attach the fixture to the mounting surface.

The supporting structure from which the unit is hung should be capable of bearing the weight of the unit, as should any clamps used to hang it. The structure should also be sufficiently rigid so as not to move or shake whilst the XR250SPOT moves during its operation. 8 M8 thread inserts (A) are located on the base of the XR250SPOT allowing for the connection of C-clamps.

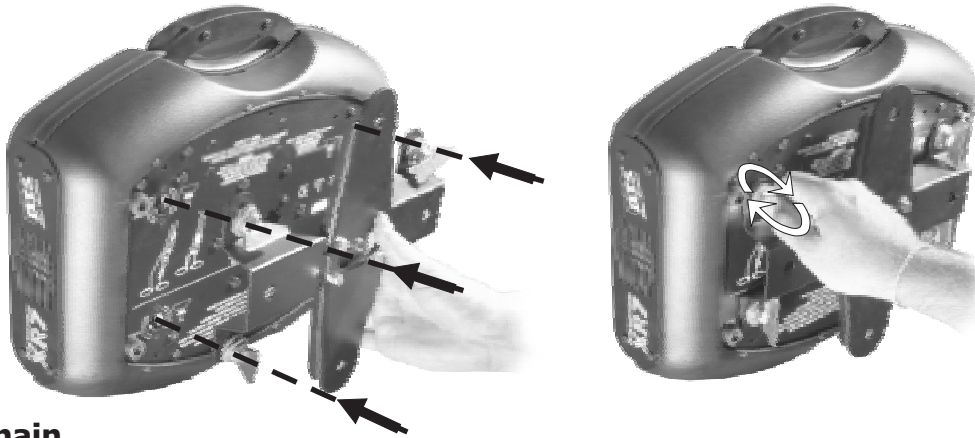

5.1 Safety chain

We recommend the use of a safety cable or chain connected to the XR250SPOT and to the suspension truss in order to avoid the fixture accidentally falling should the main fixing point fail. Make sure that the iron cable or chain can bear the weight of the entire unit. You may attach the safety chain to the two holes (A) located on the base of the fixture, as shown in the diagram below.

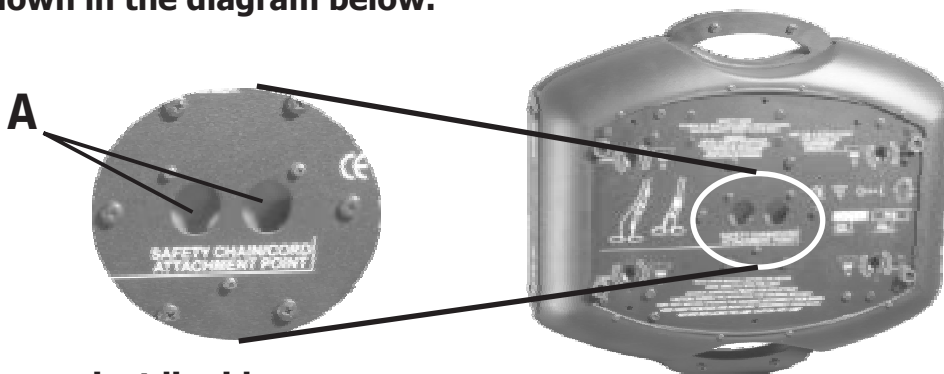

5.2 Protection against liquids

The projector contains electric and electronic components which should under no circumstances come into contact with oil, water or any other liquid. The proper working of the unit would be compromised should this occur.

5.3 Movement

The projector has a maximum movement of 540° in the base and 319° in the yoke. DO

NOT place any obstructions in the path of the projector's movement.

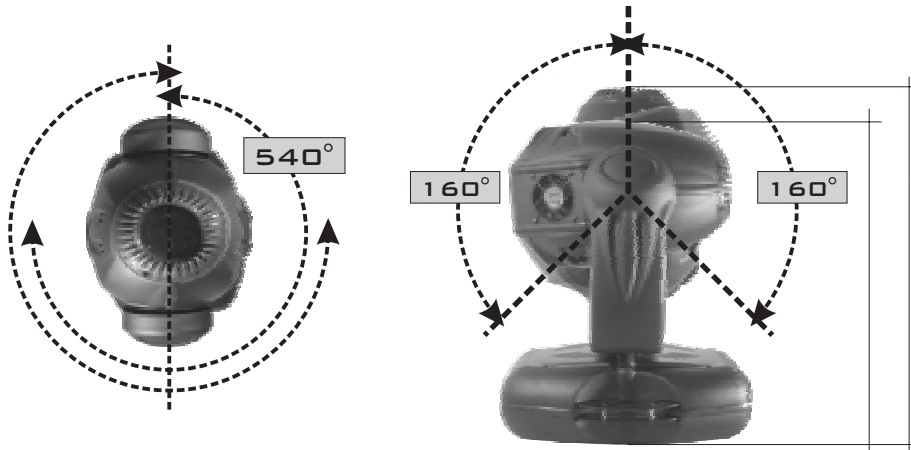

5.4 Risk of fire

Each fixture produces heat and must be installed in a well-ventilated position. The minimum recommended distance from flammable material is 0.5m. Minimum distance from the object being illuminated is 2 m.

5.5 Forced ventilation

You will note, on inspection, that the fixture features various air inlets and cooling fans located on both the base and head of the fixture. These should, under no circumstances, be blocked or obstructed whilst the projector is in operation. Doing so could cause the fixture to seriously overheat thereby compromising its proper operation.

5.6 Ambient temperature

The projector should never be installed in places that lack a constant flow of air. The ambient temperature should NOT exceed 35°C.

6- MAINS CONNECTION

XR250SPOT operates at voltage 230V at 50 or 60Hz. Prior to connecting the unit to your mains supply, ensure that the model in your possession correctly matches the mains supply available. For connection purposes, ensure that your plug is of a suitable rating of 8 amps at 230V.

Strict adherence to regulatory norms is strongly recommended.

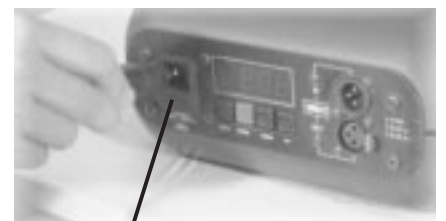

230V a 50 o 60Hz

6.1 Protection

The use of a thermal magnetic circuit breaker is recommended for each XR250SPOT. A good earth connection is essential for the correct operation of the projector.

7- DMX SIGNAL CONNECTION

The unit operates using a digital DMX 512 (1990) signal. Connection between the control box and the projector or between projectors must be carried out using a two pair screened $\varnothing 0.5$ mm cable and a CANNON XLR 5 or 3 pole connector.

Ensure that all conductors are isolated from one another and from the metal plug housing.

The plug housing must be isolated. Connect the control box signal to the DMX IN projector plug and connect it to the next projector by connecting the DMX OUT plug on the first projector to the DMX IN plug on the second.

In this way, all the projectors are cascade connected.

NB. If the display showing the DMX address flashes, then one of the following errors has occurred:

- DMX signal not present
- DMX address not valid
- DMX reception problem

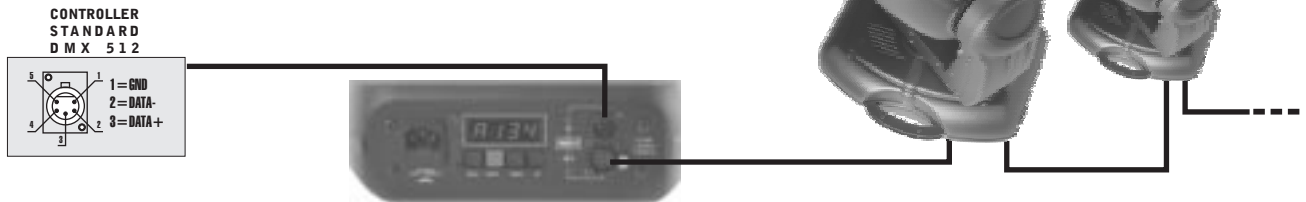

TERMINAL DMX SIGNALS:

Install when the signal wire has to be put in long distances or where there are electrical disturbances for example in a disco, concert, theater etc we advise to use a dmx terminal. the dmx terminal or even more a canon xrl-5 connected with a resistance to 120 ohm between 2 and 3 the resistance is put in the plug of the dmx of the last device that has been linked as shown following.

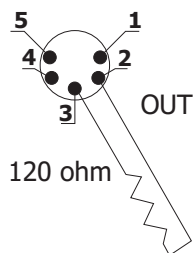

ATTACHMENT OF THE TERMINA DMX INSTALL A RESISTANCE OF 120(OHM)BETWEEN 2 AND 3 IN THE PLUG XRL AND INSERT IN THE DIGITAL PLUG OUT OF THE LAST DEVICE OF THE ROW

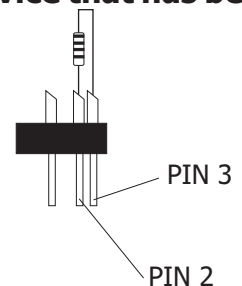

The standard configuration of the XR250SPOT is with XLR 5 pole connection.

To convert to an XLR 3 pole configuration proceed as follows:

- 1) Unscrew the external cover (photo 1).
- 2) Unscrew the screws that fix the connectors to the panel (photo 2).
- 3) Rotate the electronic card by 180° (photo 3).
- 4) Position the 3 pole connectors in the special holes and close.



Photo 1



Photo 2



Photo 3

8DMX Addresses

XR250SPOT can be used in three different modes: 8, 10 or 14 DMX channels.

If you want to use a DMX controller with 8 channels, select the 8 CH mode from the MODE menu and set the following addresses:

Projector 1 A001

Projector 2 A009

If you want to select the next projector, just add "8"

Projector 3 A017

..... A....

projector 6 A041

If you want to use a DMX controller with 10 channels, select the 10 CH mode from the MODE menu and set the following addresses:

Projector 1 A001

Projector 2 A011

If you want to select the next projector, just add "10"

Projector 3 A021

..... A....

Projector 6 A051

If you want to use a DMX controller with 14 channels, select the 14 CH mode from the MODE menu and set the following addresses:

Projector 1 A001

Projector 2 A015

If you want to select the next projector, just add "14"

Projector 3 A029

..... A....

Projector 6 A071

The address that has to be set on each projector generally depends on the number of channels that the DMX mixer allots it.

If you have a 12 channel controller, set your XR250SPOT to 10 CH MODE. The first projector will have an A001 address and if you want to select the next projector, then you have to add 12. The subsequent address will then be A0013

8.1 Changing the DMX address

- 1) Press the UP-DOWN key until you reach the required DMX number. The numbers on the display will start to flash (but the new DMX address hasn't yet been set).**
- 2) Press ENTER to confirm your selection. The numbers on the display will stop flashing and the projector is now controlled by the new 512 DMX number.**





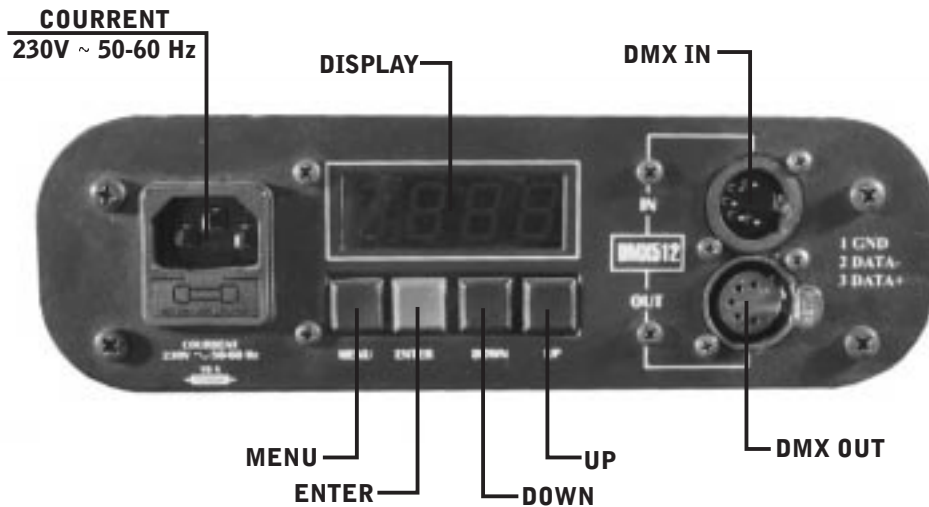































WARNING: if you press the UP-DOWN keys together the channels are calculated more quickly and you get a faster selection.

9- DISPLAY FUNCTIONS



The XR250SPOT display panel shows all the functions available. Using these functions, it is possible to change some of the parameters and to add some functions. Changing the DTS default setting can vary the functions of the appliance so that it does not respond to the DMX 512 used to control it. Carefully follow the instructions below before carrying out any variations or selections.

NOTE: the symbol  shows which key has to be pushed to obtain the function desired.

 	 	 	 		
ADD 1	Pd ir	CU	CU	Clockwise	
PAN MOVEMENT INVERSION To reverse horizontal direction of the beam from left to right and vice versa on DMX level variation.				Counterclockwise	
 	 	 	 		
td ir	CU	CU	CU	Clockwise	
TILT MOVEMENT INVERSION To reverse vertical direction of the beam from the bottom upwards and vice versa on DMX level variation				Counterclockwise	
 	 	 	 		
d ISP	AA	BB	AA	Floor position	
REVERSE DISPLAY Reverses display's reading depending on the mounting position (on the ground or suspended).				Suspension position	
 	 	 	 		
node	14CH	10CH	8 CH	14 CHANNELS	
DMX MODE To select DMX mode : 8-10-14 channels				10 CHANNELS	
				8 CHANNELS	
 					
tEst	tEst	tEst	tEst	TEST MODE Device operation test.	

<p>AUTOMATIC MODE Automatic demo game without DMX controller</p>		<p>AUTO</p>		<p>SURE</p>		<p>GAN1</p>	<p>SPEED FOCUS</p>
						<p>GAN2</p>	
						<p>GAN3</p>	
						<p>GAMP</p>	<p>SPEED</p>
						<p>ESC</p>	
<p>RESET To reset all motors function</p>		<p>RESET</p>		<p>RESET</p>			
<p>DEFAULT To restore default setting (set by DTS)</p>		<p>DFSE</p>		<p>SURE</p>			
<p>SOFTWARE VERSION Electronic card software version.</p>		<p>SOFT</p>		<p>14.11</p>		<p>Pcb 8 motors. Pcb PAN&TILT</p>	
<p>Fan control To control the fan speed .</p>		<p>FANS</p>		<p>1</p>			
				<p>12</p>			
<p>TIMER Visualization of lamp life (reset possible) and total time unit's working (reset not possible)</p>		<p>TIME</p>		<p>LAMP</p>			
				<p>Unit</p>			
				<p>RESL</p>			
<p>SPEED To change the maximum speed of PAN and TILT movement</p>		<p>SPEED</p>		<p>1</p>			
				<p>4</p>			
<p>Gobo Rotation Activates roto gobos during the gobo change</p>		<p>ROTO</p>		<p>on</p>			
				<p>off</p>			
		<p>LAMP</p>		<p>DMX</p>		<p>ON/OFF VIA DMX (DEFAULT)</p>	
				<p>On</p>		<p>FORCED ON</p>	
				<p>OFF</p>		<p>FORCED OFF</p>	
<p>REC Record mode</p>		<p>REC</p>		<p>14CH</p>		<p>2.017</p>	
				<p>10CH</p>			
<p>Slave Slave mode as run by GAM.P, Synchronised with master</p>		<p>SLAV</p>		<p>SURE</p>		<p>SLU</p>	
						<p>ESC</p>	

10.1 Automatic operation (auto)

XR250SPOT can work in automatic mode without a DMX controller. First of all connect the projectors with a DMX cable (picture below).

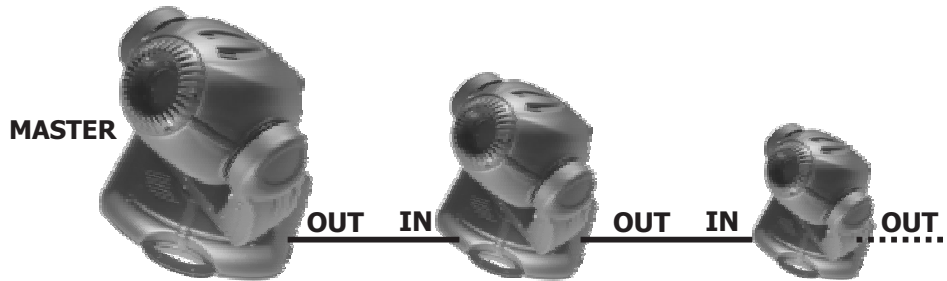

To activate Auto mode on the first unit, use the menu to run through the different modes until AUTO appears on the display, at this point press enter.

Now it is possible to choose between the different pre-programmed games (GAME 1-2-3) or Game P which is user programmable through REC mode. To confirm game activation press ENTER on the chosen GAME.

GAME 1-2-3

The first unit that will work as a Master should be placed in Automatic mode (AUTO), the other projectors have to be placed in 16 channels DMX mode (MODE 16CH) and the DMX address should be set at A001. Once a game is chosen and set it is possible to select the speed of the game (SPEE) and the gobo focus (FOCU).

GAME P

The first unit that will function as a Master must be put in (AUTO) mode, the other projectors have to be put in slave mode (selectable through the menu). In this way all units will be synchronised with the master, the projectors need not be of the same model.

On the master unit it is possible to vary the speed of the GAME P (SPEE)

NB: It is possible to run GAME P on the other units even though these do not have GAME P programmed. You can do this by setting the units to the same mode as the master is set before programming GAME P (10CH or 16CH DMX) and selecting A001 as the DMX address.

REC MODE

It is possible to programme your own game on the XR7 that will then run in AUTO mode (GAME P). Each unit can have its own programmed game.

In REC mode each projector must be set to the same mode (10CH or 16CH DMX).

For the programming of GAME P besides the channels necessary to control the unit a further 3 DMX channels are needed. So that in REC mode if the 10CH mode is selected you will need 13 channels for the programme to work correctly whereas 16CH mode would occupy 19 channels.

Connect the unit to a DMX mixer/controller, every unit should be set to its own Address (See the paragraph on DMX addresses). The projectors can also be different of models: XR7 spot/wash and XR 250 spot/wash. When you are in REC mode R.001 appears on the display (DMX address).

The three new DMX channels are:

-Scene channel

-Form 0-255 are displayed the programmable scenes (max 16 scenes M.001 M016)

-View channel:

-From 1-19 the unit runs the scene that has been saved in the units memory and it is possible to play through the other scenes using the scene channel.

-From 20-235 the unit runs the configuration given by the received input DMX values. With the channel scene it is possible to pass from one scene to the next while with REC it is possible to record the selected scene.

-From 236-255 the unit runs the configuration given by the received DMX values from the projector in that moment. It is possible to select a scene and then close the GAME P with the REC channel.

-Recording channel (REC)

Records the set scene with a variable between 0 and 255 (the display flashes indicating that the scene has been recorded).

It is advised that you keep the REC channel set to 0 and to run through the 255 only once you have decided to save the scene. If GAME P is not closed, by indicating the last scene, in playback mode all 16 scenes will be played through even if not programmed.

10.2 Pan & Tilt speed (SPEE) (default: 2)

You can set the PAN and TILT engines at high speed on your XR250SPOT.

Press menu until you see SPEE.

Press ENTER and select a speed with UP-DOWN (there are 6 speeds). Confirm by pressing ENTER.

When you use speed 6 (the highest) PAN and TILT speed is very high and your projector may loose its path. In this case, the encoder corrects the position.

10.3 Fan speed (FANS)(default: 12)

Fan speed regulation makes it possible to reduce fan noise. However, the ambient temperature must be less than 35° C.

WARNING

If the ambient temperature is too high, two thermal sensors will turn the lamp off.

In this case, you must increase the fan speed to ensure correct cooling of your XR250SPOT.

11- ERROR MESSAGES

	— ERROR: ENCODER PAN		— ERROR: colour WHEEL POSITION
	— ERROR: ENCODER TILT		— ERROR: GOBO WHEEL POSITION
	— ERROR: DMX ADDRESS		— ERROR: ROTOGOBO POSITION
	— ERROR: LOAD DATA EEPROM		— ERROR: INTERNAL COMMUNICATION
	— ERROR: SENSOR CIRCUIT COLOR		— ERROR: AUTO MODE INPUT
	— ERROR: SENSOR CIRCUIT GOBO/ROTOGOBO		— ERROR SYNCHRONIZED FREQUENCY MEASURE (SYNCHRONISM FOR LAMP ON)

12- HIDDEN MENU

For technical personnel only.

To operate this menu:

- Connect the projector to the DMX controller (DMX SIGNAL MUST BE CORRECTLY RECEIVED)
- Reset the XR250SPOT (reset from the display projector, not from the DMX controller!).
- While reset is working, press the MENU and ENTER keys at the same time.

CAL Electronic calibration of the motors.

RESN Reset EEPROM (Reset all settings. ATTENTION: by pressing this key you must repeat all previous calibrations)

ESC Exit from hidden menu.

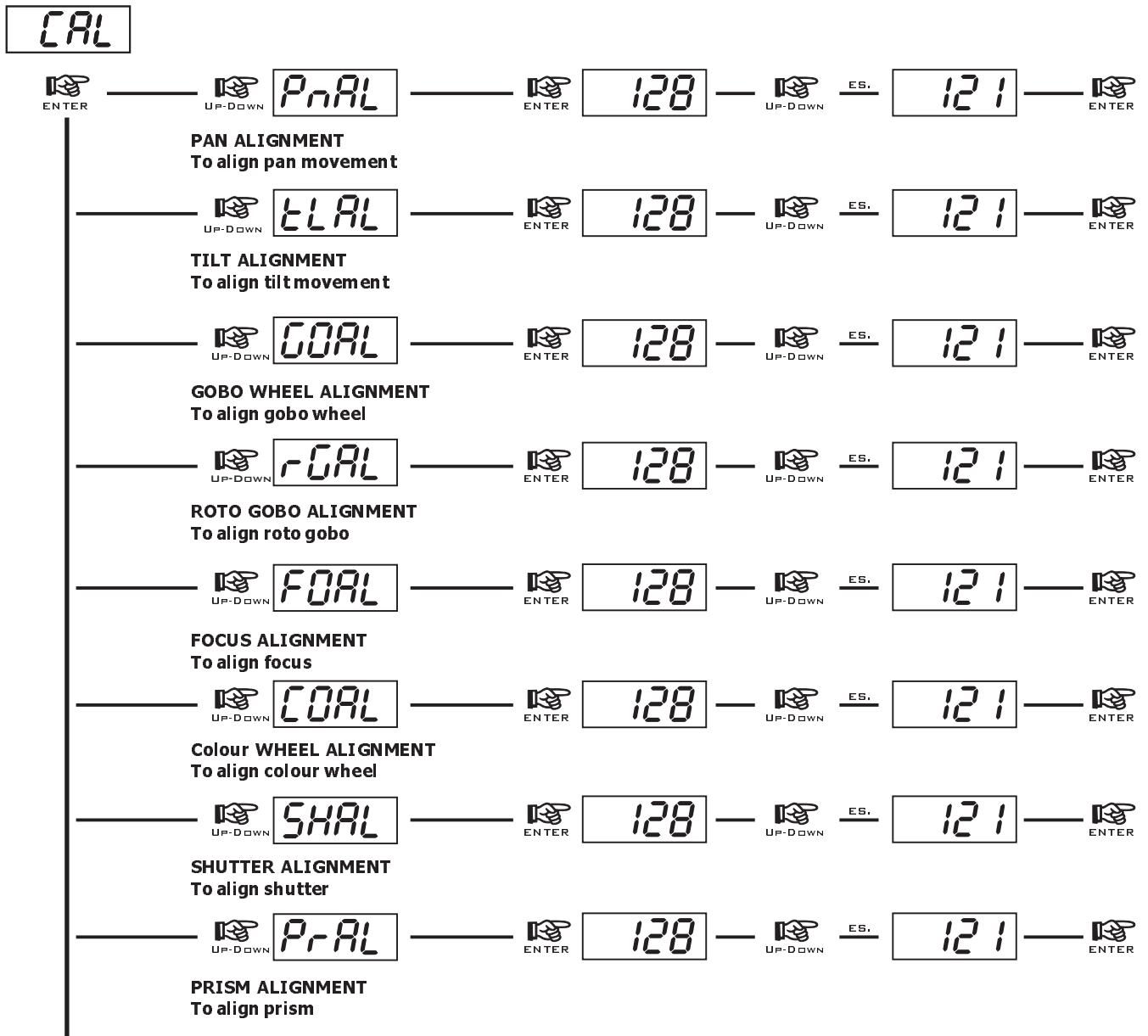

13- OPENING UP THE PROJECTOR HOUSING

It is possible to inspect the inside of the projector by removing the cover as indicated below.

WARNING

REMOVE MAINS POWER PRIOR TO ACCESSING THE PROJECTOR'S INTERNAL COMPONENTS.

- 1) Loosen the screws which fix the upper and lower covers (photo 1) and unscrew the side covers (photo 2).
- 2) Once unscrewed, simply lift the covers to access the internal components (photo 3).



Photo 1

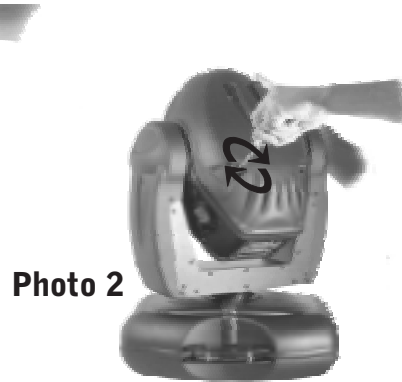

Photo 2

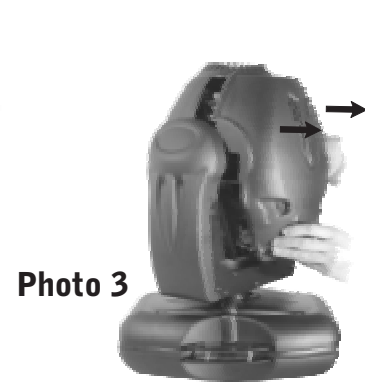

Photo 3

14- REPLACING GOBOS

XR250SPOT uses a mechanical system which allows the units gobos to be removed without the use of special equipment. Replacement gobos should be made of either heat resistant glass or metal.

An ever-increasing range of gobos is available from your DTS sales network.

Gobo dimensions are as follows:

∅ external = 28 mm (or 27 mm from the back)

∅ of image with defined edge = 24 mm

thickness = from 0.2 to 3.5 mm

When replacing gobos as shown in the following diagrams, ensure that the projector is not turned on.

- 1) Open the projector housing as described above.
- 2) Loosen the screws as shown (photo 1) and remove the metal leaf to allow easier access to the gobos.
- 3) Release the gobo retaining spring and carefully remove the gobo (photo 2-3).
- 4) Reverse the procedure to install a replacement gobo.

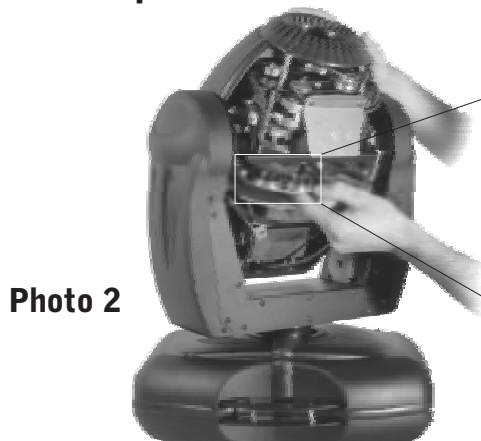

Photo 2

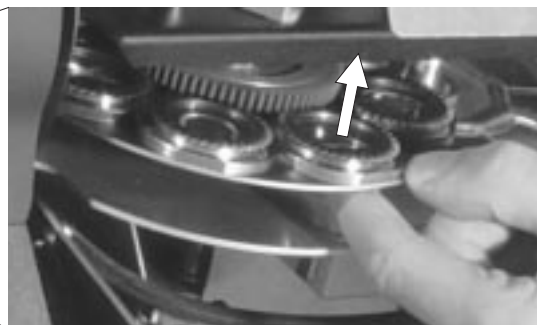

Photo 3

15- PERIODIC CLEANING E CONTROLS

15.1 Lenses and reflectors

Even a fine layer of dust can reduce the luminous output substantially. Regularly clean all lenses and the raylight reflector using a soft cotton cloth, dampened with a special lens cleaning solution.

15.4 Fans and air passages

The fans and air passages must be cleaned approximately every 6 weeks. This periodic cleaning will depend of course, on the conditions in which the projector is operating. Suitable instruments for performing this type of maintenance are a brush and a common vacuum cleaner or an air compressor. If necessary, clean the fans and air passages more frequently.

15.3 Lamp

The lamp should be replaced if there is any visible damage or deformation due to heat. This will help to avoid the danger of the lamp exploding.

15.4 Mechanical parts

Periodically check all mechanical parts gears, guides, belts, etc... For wear and tear, replacing them if necessary. Periodically check the lubrication of all components, particularly the parts subject to high temperatures. If necessary, lubricate with suitable lubricant, available from your D.T.S. distributor. Check the tension of the belts and adjust if necessary.

15.5 Electrical components

Check all electrical components for correct earthing and proper attachment of all connectors, refastening if necessary.

15.6 Fuse replacement

Locate the fuse, which protects the lamp and electronics, in the base of the XR250SPOT. Using a multimeter, test the condition of the fuse, replacing it with one of equivalent type if necessary.

15.7 WARNING!

Disconnect mains power prior to removing the projector housing.

17- 8 MOTORS CARD

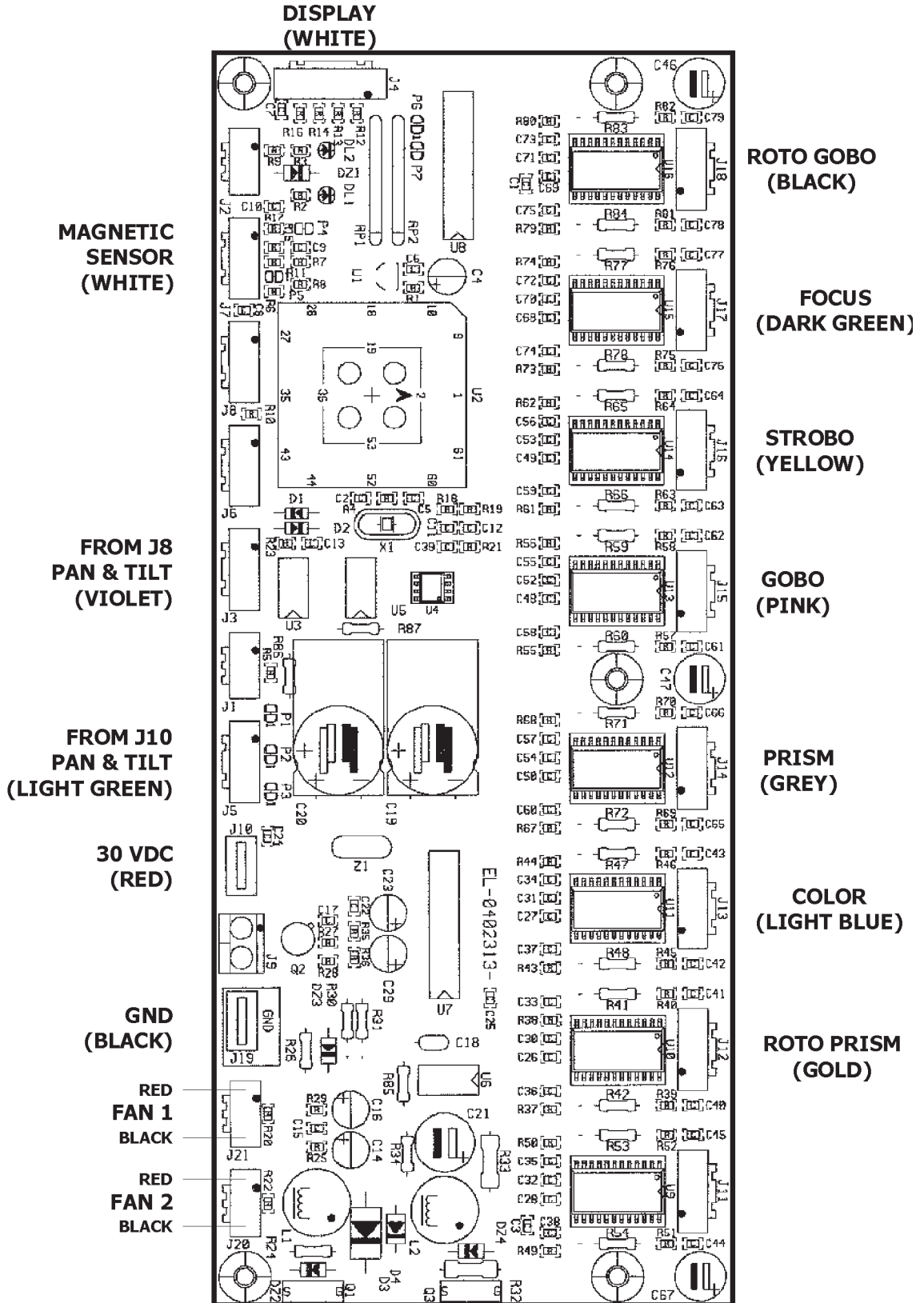

18- DISPLAY CARD

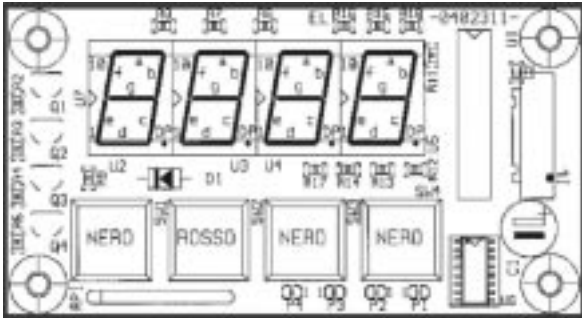

FROM J4
8 MOTORI

ON/OFF LAMP CARD

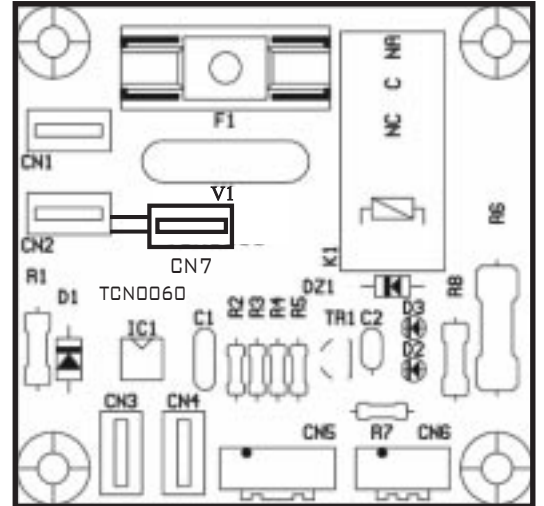

24V~

FROM J16
PAN & TILT
CARD

FROM J7
PAN & TILT
CARD

SENDING AGAIN CARD

IF THE PCB DOESN'T WORK MOVE THE CABLE
"IN LAMP" FROM Cn1 TO Cn7

TO DELETE **SnEr** ERROR FROM DISPLAY IN

MENU **LAMP** SELECT **off**

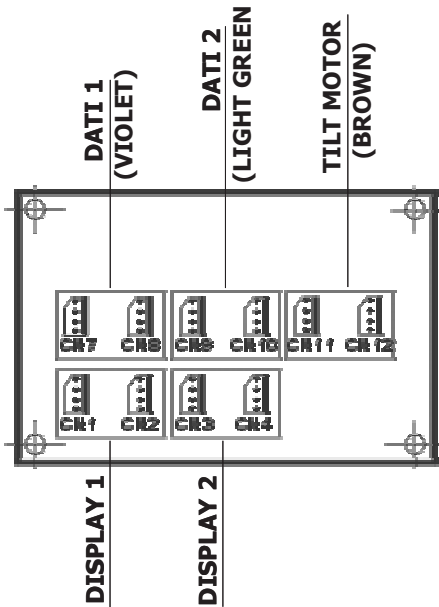

ENCODER PAN
(RED)

ENCODER TILT
(ORANGE)

PAN & TILT CARD

PAN (WHITE) TILT (BROWN) GND (BLACK)

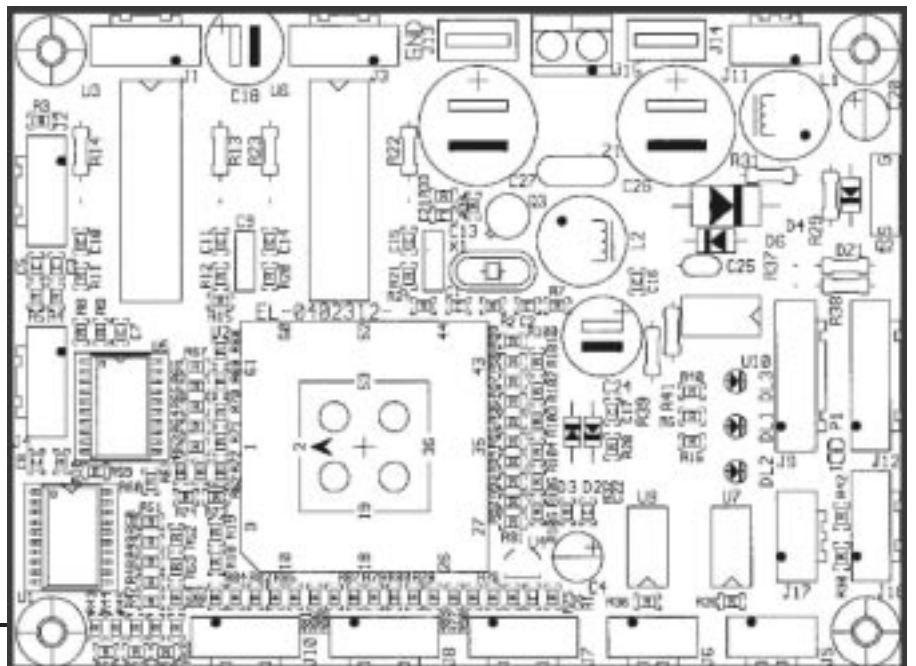

FROM J5
8 MOTORI
(LIGHT GREEN)

FROM J3
8 MOTORI
(VIOLET)

DMX ING
(WHITE)

8 CHANNELS MODE (8CH)

- 1 ROTOGOBO
- 2 COLOR
- 3 GOBO
- 4 SHUTTER / STROBE
- 5 PAN
- 6 TILT
- 7 PRISM/ROTOPRISM
- 8 FOCUS

10 CHANNELS MODE (10CH)
(DEFAULT)

- 1 ROTOGOBO
- 2 COLOR
- 3 GOBO
- 4 SHUTTER/STROBE
- 5 PAN
- 6 TILT
- 7 PRISM/ROTOPRISM
- 8 FOCUS
- 9 PAN lsb
- 10 TILT lsb

DMX CHANNELS	1	Parameter: ROTOGOBO
--------------	----------	----------------------------

DMX range Value	Mid point DMX value	Move range (gradi)	Mode	Option	FUNCTION
0-127	63				Proportional da 0° a 360°
128-180	154				Left rotation
181-202	191				Stop
203-255	229				Right rotation

DMX CHANNELS	2	Parameter: COLORE
--------------	----------	--------------------------

DMX range Value	Mid point DMX value	Move range (gradi)	Mode	Option	FUNCTION
0-10	5				Color1
11-21	16				Bicolor ½
22-32	27				Color2
33-43	38				Bicolor 2/3
44-54	49				Color3
55-65	60				Bicolor 3/4
66-76	71				Color4
77-87	82				Bicolor 4/5
88-98	93				Color5
99-109	104				Bicolor 5/6
110-120	115				Color6
121-131	126				Bicolor 6/7
132-142	137				Color7
143-153	148				Bicolor 7/8
154-164	159				Color8
165-175	170				Bicolour 8/9
176-186	181				Color9
187-197	192				Bicolour 9/1
198-200	199				Right rotation speed 1 min.
201-203	202				Right rotation speed 2

204-206	205				Right rotation speed 3
207-209	208				Right rotation speed 4
210-212	211				Right rotation speed 5
213-215	214				Right rotation speed 6
216-218	217				Right rotation speed 7
219-221	220				Right rotation speed 8
222-224	223				Right rotation speed 9 max.
225-228	226				Stop
229-231	230				Left rotation speed 1 min.
232-234	233				Left rotation speed 2
235-237	236				Left rotation speed 3
238-240	239				Left rotation speed 4
241-243	242				Left rotation speed 5
244-246	245				Left rotation speed 6
247-249	248				Left rotation speed 7
250-252	251				Left rotation speed 8
253-255	254				Left rotation speed 9 max.

DMX CHANNELS	3	Parameter: GOBO WHEEL
--------------	---	------------------------------

DMX range Value	Mid point DMX value	Move range (gradi)	Mode	Option	FUNCTION
0-25	12				Open
26-51	38				Gobo 1
52-77	64				Gobo 2
78-103	90				Gobo 3
104-129	116				Gobo 4
130-155	142				Gobo 5
156-181	168				Gobo 6
182-207	194				Gobo 7
208-213	210				Speed rotation 1 min.
214-219	216				Rotazione peed 2
220-225	222				Speed rotation 3
226-231	228				Speed rotation 4
232-237	234				Speed rotation 5
238-243	240				Speed rotation 6
244-249	246				Speed rotation 7
250-255	252				Speed rotation 8 max.

DMX CHANNELS	4	Parameter: SHUTTER / STROBE
--------------	---	------------------------------------

DMX range Value	Mid point DMX value	Move range (gradi)	Mode	Option	FUNCTION
0-9	4				Black out
10-85	47				Dimmer
86-95	90				Strobo random speed
96-105	100				Strobo speed 1 min.
106-115	110				Strobo speed 2

116-125	120				Strobo speed 3
126-135	130				Strobo speed 4
136-145	140				Strobo speed 5
146-155	150				Strobo speed 6 max.
156-165	160				Pulsato open speed 1 min.
166-175	170				Pulsato open speed 2
176-185	180				Pulsato open speed 3
186-195	190				Pulsato open speed 4 max
196-205	200				Pulsato closed speed 1 min.
206-215	210				Pulsato closed speed 2
216-225	220				Pulsato closed speed 3
226-235	230				Pulsato closed speed 4 max.
236-245	240				Color/gobo/pan/tilt in black out
246-255	250				Open

DMX CHANNELS	5	Parameter: PAN msb
--------------	---	---------------------------

DMX CHANNELS	6	Parameter: TILT msb
--------------	---	----------------------------

DMX CHANNELS	7	Parameter: PRISM/ROTOPRISM
--------------	---	-----------------------------------

DMX range Value	Mid point DMX value	Move range (gradi)	Mode	Option	FUNCTION
0-63	31				No effect
64-145	104				Prism on
128-191	159				Left rotation
192-255	223				Right rotation

DMX CHANNELS	8	Parameter: FOCUS
--------------	---	-------------------------

DMX range Value	Mid point DMX value	Move range (gradi)	Mode	Option	FUNCTION
0-255	127				proportional

DMX CHANNELS	9	Parameter: PAN lsb
--------------	---	---------------------------

DMX CHANNELS	10	Parameter: TILT lsb
--------------	----	----------------------------

N.B :THE CHANNELS 9-10 ARE IGNORED IN 8 CHANNELS MODE

14 CHANNELS MODE (14CH)

- 1 PAN msb
- 2 PAN lsb
- 3 TILT msb
- 4 TILT lsb
- 5 SPEED MOVEMENT
- 6 DIMMER
- 7 SHUTTER
- 8 COLOR
- 9 PROPORTIONAL COLOR (Prioritario)
- 10 GOBO
- 11 ROTOGOBO
- 12 PRISM/ROTOPRISM
- 13 FOCUS
- 14 RESET

DMX CHANNELS	1	Parameter: PAN msb
--------------	----------	---------------------------

DMX CHANNELS	2	Parameter: PAN lsb
--------------	----------	---------------------------

DMX CHANNELS	3	Parameter: TILT msb
--------------	----------	----------------------------

DMX CHANNELS	4	Parameter: TILT lsb
--------------	----------	----------------------------

DMX CHANNELS	5	Parameter: MOVEMENT SPEED
--------------	----------	----------------------------------

DMX range Value	Mid point DMX value	Move range (gradi)	Mode	Option	FUNCTION
0-10	5				Standard
11-25	18				Fast movement
26-127	76				Vector mode from fast to slow
128-247	187				Variable time reaction to DMX signal (fast to slow)
248-255	251				Slow reaction time to DMX signal

DMX CHANNELS	6	Parameter: DIMMER
--------------	----------	--------------------------

DMX range Value	Mid point DMX value	Move range (gradi)	Mode	Option	FUNCTION
0-8	4				Black-out
9-255					Dimmer proportional

DMX CHANNELS	7	Parameter: SHUTTER
--------------	---	---------------------------

DMX range Value	Mid point DMX value	Move range (gradi)	Mode	Option	FUNCTION
0-9	5				Black-out
10-23	16				Strobo random speed
24-37	30				Strobo speed 1 min.
38-51	44				Strobo speed 2
52-65	58				Strobo speed 3
66-79	72				Strobo speed 4
80-93	86				Strobo speed 5
94-107	100				Strobo speed 6 max.
108-121	114				Pulsato open speed 1 min.
122-135	128				Pulsato open speed 2
136-149	142				Pulsato open speed 3
150-163	156				Pulsato open speed 4 max.
164-177	170				Pulsato closed speed 1 min.
178-191	184				Pulsato closed speed 2
192-205	198				Pulsato closed speed 3
206-219	212				Pulsato closed speed 4 max.
220-227	225				Color e Gobo in black-out
228-233	230				Pan e Tilt in black-out
234-255	244				Open

DMX CHANNELS	8	Parameter: COLOR
--------------	---	-------------------------

DMX range Value	Mid point DMX value	Move range (gradi)	Mode	Option	FUNCTION
0-10	5				Color1
11-21	16				Bicolor 1/2
22-32	27				Color2
33-43	38				Bicolor 2/3
44-54	49				Color3
55-65	60				Bicolor 3/4
66-76	71				Color4
77-87	82				Bicolor 4/5
88-98	93				Color5
99-109	104				Bicolor 5/6
110-120	115				Color6
121-131	126				Bicolor 6/7
132-142	137				Color7
143-153	148				Bicolour 7/8
154-164	159				Color8
165-175	170				Bicolour 8/9
176-186	181				Color9
187-197	192				Bicolour 9/1
198-200	199				Right rotation speed 1 min.

201-203	200				Right rotation speed 2
204-206	205				Right rotation speed 3
207-209	208				Right rotation speed 4
210-212	211				Right rotation speed 5
213-215	214				Right rotation speed 6
216-218	217				Right rotation speed 7
219-221	220				Right rotation speed 8
222-224	223				Right rotation speed 9 max.
225-228	226				Stop
229-231	230				Left rotation speed 1 min.
232-234	233				Left rotation speed 2
235-237	236				Left rotation speed 3
238-240	239				Left rotation speed 4
241-243	242				Left rotation speed 5
244-246	245				Left rotation speed 6
247-249	248				Left rotation speed 7
250-252	251				Left rotation speed 8
253-255	254				Left rotation speed 9 max.

DMX CHANNELS	9	Parameter: PROPORTIONAL COLOR (PRIORITARIO)
--------------	---	--

DMX range Value	Mid point DMX value	Move range (gradi)	Mode	Option	FUNCTION
0-10	5				No effect
11-255					Color proportional

DMX CHANNELS	10	Parameter: GOBO
--------------	----	------------------------

DMX range Value	Mid point DMX value	Move range (gradi)	Mode	Option	FUNCTION
0-25	12				Open
26-51	38				Gobo 1
52-77	64				Gobo 2
78-103	90				Gobo 3
104-129	116				Gobo 4
130-155	142				Gobo 5
156-181	168				Gobo 6
182-207	194				Gobo 7
208-213	210				Speed rotation 1 min.
214-219	216				Speed rotation 2
220-225	222				Speed rotation 3
226-231	228				Speed rotation 4
232-237	234				Speed rotation 5
238-243	240				Speed rotation 6
244-249	246				Speed rotation 7
250-255	252				Speed rotation 8 max.

DMX CHANNELS	11	Parameter: ROTO GOBO
--------------	-----------	-----------------------------

DMX range Value	Mid point DMX value	Move range (gradi)	Mode	Option	FUNCTION
0-127					Proportional da 0° a 360°
128-180					Left rotation
181-202	191				Stop
203-255					Right rotation

DMX CHANNELS	12	Parameter: PRISM/ROTOPRISM
--------------	-----------	-----------------------------------

DMX range Value	Mid point DMX value	Move range (gradi)	Mode	Option	FUNCTION
0-63	32				No effect
64-127	95				Prism on
128-191					Left rotation
192-255					Right rotation

DMX CHANNELS	13	Parameter: FOCUS
--------------	-----------	-------------------------

DMX range Value	Mid point DMX value	Move range (gradi)	Mode	Option	FUNCTION
0-255					proportional

DMX CHANNELS	14	Parameter: RESET
--------------	-----------	-------------------------

DMX range Value	Mid point DMX value	Move range (gradi)	Mode	Option	FUNCTION
0-29					No effect
30-85					Lamp OFF (activated after 3 seconds)
86-170					Reset internal motors
171-235					Total reset
236-255					Lamp ON (activated after 3 seconds)